



Programmable Controller

MELSEC

designed with automation in mind

GLOBAL IMPACT OF MITSUBISHI ELECTRIC



Through Mitsubishi Electric's vision, "Changes for the Better" are possible for a brighter future.

Changes for the Better

"Changes for the Better" represents the Mitsubishi Electric Group's attitude to "always strive to achieve something better", as we continue to change and grow. Each one of us shares a strong will and passion to continuously aim for change, reinforcing our commitment to creating "an even better tomorrow".

Mitsubishi Electric is involved in many areas including the following:

Energy and Electric Systems

A wide range of power and electrical products from generators to large-scale displays.

Electronic Devices

A wide portfolio of cutting-edge semiconductor devices for systems and products.

Home Appliance

Dependable consumer products like air conditioners and home entertainment systems.

Information and Communication Systems

Commercial and consumer-centric equipment, products and systems.

Industrial Automation Systems

Maximizing productivity and efficiency with cutting-edge automation technology.

Our advances in AI and IoT are adding new value to society in diverse areas from automation to information systems. The creation of game-changing solutions is helping to transform the world, which is why we are honored to be recognized in the 2019 "Forbes Digital 100" as one of world's most influential digital corporations.



Committed to ever higher customer satisfaction

Mitsubishi Electric is a global leader in the research, manufacturing and marketing of electrical and electronic equipment used in areas such as communications, consumer electronics, industrial technology, energy and transportation. Within this, the industrial automation business has grown significantly since the first induction motor was manufactured over 90 years ago and has closely followed the automation industry in Japan, Asia, and beyond. Mitsubishi Electric industrial automation boasts a wide-range of product areas such as production control, drives, and mechatronics that are used in various industries. In addition, Mitsubishi Electric offers e-F@ctory and iQ Platform, leveraging its total industrial automation solution portfolio.



Intelligence in everything automated—MELSEC

The MELSEC (Mitsubishi ELectric SEquence Control) brand is well known in the automation industry for robust quality and excellent performance that realizes a reduction in total cost of ownership (TCO). The MELSEC lineup consists of various products, the flagship products being the MELSEC-Q Series and recently introduced MELSEC iQ-R Series. These high-end programmable controllers, mainly used for controlling processes in manufacturing lines and advanced machines are complimented by small- to medium-sized controllers like the MELSEC-L Series, MELSEC-F Series and the new MELSEC iQ-F Series, which are commonly utilized for cell manufacturing and stand-alone applications. Over the years, a main characteristic of the MELSEC Series has been seamless connection, from the sensor level all the way through to Enterprise covering all aspects of manufacturing.

INDEX

FA Integrated Solution e-F@ctory.....	4	Application-specific CPUs		Network	40
MELSEC Series.....	6	MELSEC Safety.....	28	MELSEC History.....	42
Application Examples.....	8	MELSEC Process Control.....	29	Support.....	44
MELSEC Selection Guide.....	10	C Controller.....	30		
Programmable Controller		Servo System Controller.....	31		
MELSEC iQ-R Series.....	12	Robot Controller.....	32		
MELSEC-Q Series.....	18	CNC CPU.....	33		
MELSEC-L Series.....	20	Engineering Software			
MELSEC iQ-F Series.....	22	MELSOFT iQ Works.....	34		
MELSEC-F Series.....	26	MELSOFT GX Works3.....	36		
		MELSOFT GX Works2.....	38		

Maximizing productivity and reducing costs across the entire enterprise

e-F@ctory is the Mitsubishi Electric solution for improving the performance of any manufacturing enterprise by enhancing productivity, and reducing the maintenance and operations costs together with seamless information flow throughout the plant. e-F@ctory uses a combination of factory automation and IT technologies, offering solutions to reduce the total cost of development, production, and maintenance by supporting advanced *Monozukuri**.

e-F@ctory helps to reduce overall costs and is achieved in the following four areas:

* Monozukuri is an initiative started in Japan for promoting its unique manufacturing style for continuous improvement in production processes and operations. The word is derived by combining the words "mono", the thing that is manufactured, and "zukuri", the process of manufacturing

Reduce energy costs

Energy saving solution

Modern manufacturing depends much on reducing energy costs as a way to realize an efficient manufacturing enterprise. e-F@ctory supports this by allowing visualization of real-time energy usage, helping to reduce the overall energy consumption.

Integrate FA and IT systems at low cost

Edge-computing (FA-IT information connection)

Edge computing enables point-of-origin processing by seamless data collection and analysis, realizing optimization of manufacturing operations improving various elements such as productivity and quality.

Reduce development, production, and maintenance costs

iQ Platform

The iQ Platform minimizes costs at all phases of the automation life cycle by improving development times, enhancing productivity, reducing maintenance costs, and making information more easily accessible. Integration is at the heart of the iQ Platform, with a highly intelligent controller platform as the core, combined with a seamless communication network and an integrated engineering environment.



Reduce setup and maintenance costs

iQ Sensor Solution

Easily setup and maintain various types of sensors. Maintenance and design costs can be reduced as compatible iQSS partner sensors can be managed together.



IT system

Edge-computing

Shop floor



For further details, please refer to the "Mitsubishi Integrated Solution e-F@ctory", "iQ Platform Integrated Automation Concept", and "iQ Sensor Solution" catalogs.

L(NA)16012E, L(NA)08340ENG, L(NA)16029ENG

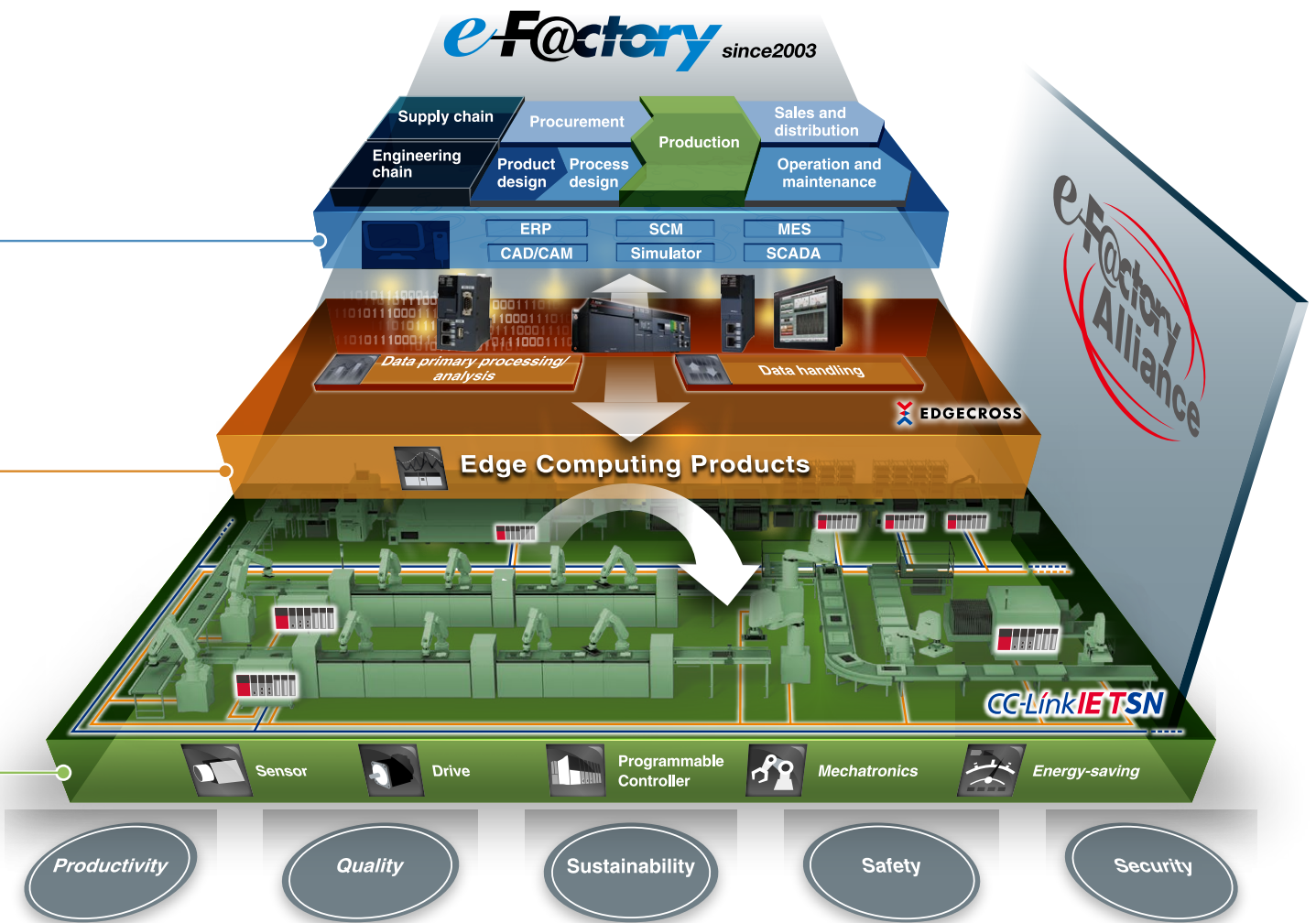

Best-in-class solutions across the ecosystem

e-F@ctory Alliance

The e-F@ctory Alliance is an ecosystem offering best-in-class solutions by combining products between Mitsubishi Electric and its various partners. Close collaboration with such partners broaden the choices for the customer and realize the best solution possible.



MELSEC

Comprehensive controller lineup available to meet customers' requirements, from small-scale and stand-alone to medium- and large-scale systems

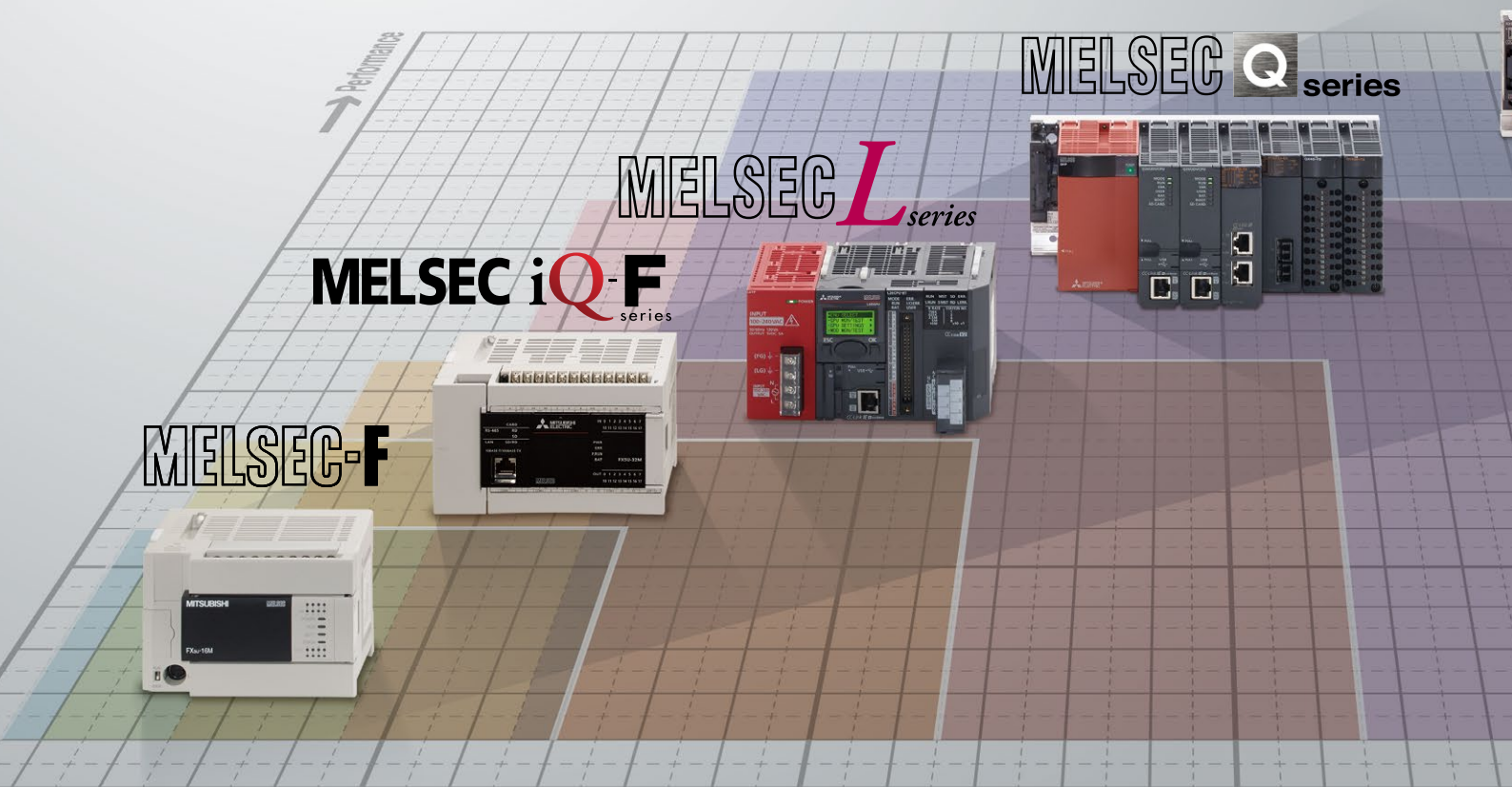

Application-specific CPUs



Safety CPU**



Process/
Redundant CPU



C Controller

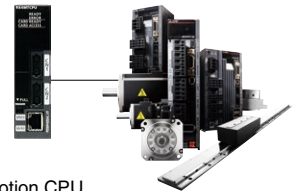

Motion CPU



These best-in-class CPUs, integrated into the iQ Platform, are designed for specific needs across various different industry areas.

**1: R1SFCPU-SET includes both a safety CPU and safety function module

MELSEC iQ-R series



Optimum automation control area

→ System size

Medium- to large-scale control



MELSEC iQ-R Series

A next-generation programmable automation controller (PAC), the MELSEC iQ-R Series incorporates a revolutionary high-speed system bus that improves productivity through advanced performance and functionality.



MELSEC-Q Series

The first to incorporate the multiple CPU architecture, the MELSEC-Q Series wide-range of CPUs enables control of multiple operations, improving the performance and scalability of the overall production system.

Small- to medium-scale control



MELSEC-L Series

The MELSEC-L Series is a baseless highly scalable controller ideal for applications having limited space. With various I/O functionality embedded into the CPU head, exceptional cost versus performance is achieved in a compact body.

Small-scale and stand-alone



MELSEC iQ-F Series

Designed to provide outstanding performance and superior drive control, the MELSEC iQ-F Series is a high-performance compact-class controller with a rich assortment of integrated functions.



MELSEC-F Series

Incorporating abundant features with a flexible system configuration, the MELSEC-F Series has a power supply, CPU and I/Os into a single compact body. Furthermore, a diverse range of options are available to further expand its capabilities.



Robot CPU



CNC CPU



MELSEC Designed with automation in mind

Mitsubishi Electric offers a wide range of controllers capable of satisfying the diversified application needs in various industries. The high-speed, high-accuracy controllers in the MELSEC series covers them all, providing highly flexible cost-effective solutions.

- iQ-R : MELSEC iQ-R Series
- Q : MELSEC-Q Series
- L : MELSEC-L Series
- iQ-F : MELSEC iQ-F Series
- F : MELSEC-F Series
- S : Safety
- P : Process/Redundant system
- C : C Controller
- M : Servo system controller
- R : Robot controller
- N : CNC CPU

Automotive

- iQ-R
- Q
- S
- M
- R
- N



Improve productivity and realize flexibility in different automotive assembly lines with high-accuracy motion control, including linear/circular interpolation and electric cam profile.

Automated warehouse

- iQ-R
- Q
- iQ-F
- F
- C
- M
- R



Realize advanced logistics coordination and eliminate errors in repetitive processes. Servo-based high-speed material handling and highly accurate positioning improving productivity and reduce energy consumption.

Food and beverage, CPG

- iQ-R
- Q
- L
- iQ-F
- F
- P
- M



Realize improvements in various packaging applications such as high-speed filling, which requires a highly accurate, continuous feed rate and precision.

Semiconductor

- iQ-R
- Q
- S
- C
- M

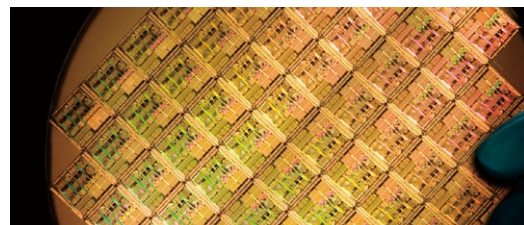

Reduce maintenance costs using the high-durability MELSEC Series. Having the compact, robust design desired for semiconductor manufacturing, MELSEC products solve the small footprint, high-performance requirements.

Pick-and-place

- iQ-R
- M

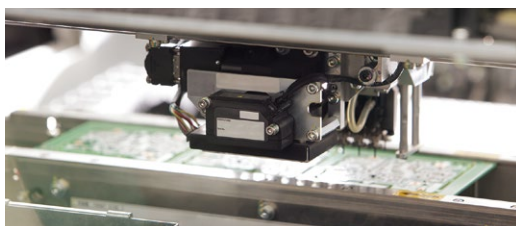

Achieve highly precise, fast and accurate placement of components in various sizes and shapes such as that required by SMT pick-and-place equipment, further improving productivity.

Flat panel display (FPD)

- iQ-R
- Q
- S
- C
- M
- R



Improve the large data bandwidth and high performance requirements common in FPD manufacturing processes using MELSEC's integrated control platform. The integrated controller and network solution offer increased flexibility and enhanced performance.

Chemical

iQ-R Q P



Improve control of processes involving chemical manufacturing using highly scalable solutions that integrate process control and factory automation.

Renewable energy

iQ-R P C



Easily integrate renewable energy plant management utilizing plant-wide data acquisition and extensive real-time control, thereby reducing overall investment and maintenance costs.

Printing

iQ-R Q C M



Realize high-speed, high-quality printing through various solutions offered depending on the printing process involved such as roll paper feed-in, offset printing, binding, and sortation.

Machine tool

iQ-R Q L iQ-F F N



Improve productivity, operating efficiency and overall equipment effectiveness using the scalable control of MELSEC products, supporting tasks such as drilling, grinding, and milling.

Inspection machines

iQ-R C



Easily integrate Inspection machine control into automated systems, thereby reducing maintenance and overall operational costs.

Building automation

iQ-R Q L iQ-F F C



Increase security and ensure effective use of energy management capabilities by supporting various building automation protocols, resulting in a reduced carbon footprint.

Injection molding

iQ-R Q iQ-F F M



Achieve reductions in machine operation costs and improve productivity by integrating MELSEC controllers that utilize an easy-to-use control platform combined with highly accurate motion control.

General automation

iQ-R Q L iQ-F F C



Alternative automation applications such as automatic car washes and automated hydroponic farming require a high-level of automation similar to industrial solutions.

MELSEC Selection Guide

Controller lineup

Series	Modular type	Modular type	Baseless type			
	MELSEC iQ-R PAC (Programmable automation controller)	MELSEC-Q Programmable controller CPU	MELSEC-L Programmable controller CPU			
Lineup	<ul style="list-style-type: none"> Programmable controller CPU: 8 models CC-Link IE embedded CPU: 5 models Safety CPU: 4 models Process CPU^{*1}: 8 models C Controller: 1 model Motion CPU: 3 models Robot controller: 1 model CNC CPU: 1 model 	<ul style="list-style-type: none"> Programmable controller CPU (Universal model): 25 models Process CPU: 4 models Redundant CPU: 2 models C Controller: 4 models Motion CPU: 2 models Robot controller: 1 model CNC CPU: 1 model 	<ul style="list-style-type: none"> Programmable controller CPU Sink type: 5 models Source type: 5 models 			
Control method	Stored program cyclic operation	Stored program cyclic operation	Stored program cyclic operation			
I/O control mode	Refresh mode	Refresh mode	Refresh mode			
Programming language	<ul style="list-style-type: none"> Ladder diagram Structured text (ST) Sequential function chart (SFC)^{*2} Function block diagram (FBD/LD) Function block (FB) C/C++^{*4} 	<ul style="list-style-type: none"> Ladder diagram Structured text (ST) Instruction list MELSAP3 (SFC), MELSAP-L Function block diagram (FBD) Function block (FB) C/C++^{*4} 	<ul style="list-style-type: none"> Ladder diagram Structured text (ST) Instruction list MELSAP3 (SFC), MELSAP-L Function block (FB) 			
Engineering environment	MELSOFT GX Works3 MELSOFT MT Works2 CW Workbench	MELSOFT GX Works2 MELSOFT PX Developer MELSOFT MT Works2 CW Workbench	MELSOFT GX Works2			
Program size (K step)	1200	1000	260			
Number of I/O points [X/Y] (point)	4096	4096	4096			
Device/label memory/ standard RAM (K byte)	3380	1792	768			
Data memory/ standard ROM (byte)	40M	16M	2M			
Processing speed						
LD instruction (ns)	0.98	1.9	9.5			
MOV instruction (ns)	1.96	3.9	19			
Floating point addition (μs)	0.01	0.014	0.057			
Memory interface						
Extended SRAM cassette	●	● ^{*3}	—			
SD memory card	●	● ^{*3}	● ^{*6}			
SRAM card, FLASH card, ATA card	—	● ^{*5}	—			
External interface						
USB	●	●	●			
Ethernet (1000BASE-T ^{**} /100BASE-TX/10BASE-T)	●	● ^{*8}	● ^{*5}			
RS-232	—	● ^{*9}	● ^{*10}			
RS-422/485	—	—	—			
Display unit	—	—	●			
CC-Link IE connection port						
Ethernet (1000BASE-T/100BASE-TX/10BASE-T)	● ^{*12}	—	—			
Network connectivity (adapter/module)						
Ethernet (1000BASE-T ^{**} /100BASE-TX/10BASE-T)	●	●	●			
CC-Link IE Control	●	—	—			
CC-Link IE Field	●	● ^{*15}	—			
CC-Link	●	●	●			
CC-Link/LT	—	●	●			
SSCNET III/H	●	●	●			
AnyWire	●	●	●			
BACnet [®]	●	●	●			
MODBUS [®] /TCP	●	●	●			
MODBUS [®]	●	●	●			
General specifications/conformed standards						
Operating ambient temperature	0...55°C (60°C ^{*17})	0...55°C	0...55°C			
International safety standards (ISO 13849-1 PL e, IEC 61508 SIL 3)	● ^{*18}	—	—			
Standard on corrosive atmosphere (IEC 60721-3-3: 1994 3C2)	● ^{*19}	—	—			
CE: Council Directive of the European Communities	●	●	●			
UL: Underwriters Laboratories Listing	●	●	●			
LR: Lloyd's Register of Shipping approval	●	●	—			
DNV GL Maritime approval	●	●	—			
RINA: Italian Maritime approval	●	●	—			
NK: ClassNK approval	●	●	—			
ABS: American Bureau of Shipping approval	●	●	—			
BV: Bureau Veritas approval	●	●	—			
Key features/functions	<ul style="list-style-type: none"> Line manufacturing Distributed control Small-scale I/O control Large-scale I/O control Security Inter-modular sync Built-in database Integrated network Multiple CPU 	<ul style="list-style-type: none"> Process control High-reliability control C programming Data logging IT gateway Advanced motion Safety Real-time monitor 	<ul style="list-style-type: none"> Line manufacturing Distributed control Large-scale I/O control Integrated network Multiple CPU Process control High-reliability control 	<ul style="list-style-type: none"> C programming Data logging IT gateway Advanced motion 	<ul style="list-style-type: none"> Machine control Distributed control Small-scale I/O control Large-scale I/O control Space/cost saving Integrated network Extensive built-in functions 	<ul style="list-style-type: none"> Data logging Motion control Real-time monitor

*1: Supports redundant system when paired with R6RFM

*2: SFC is not supported in redundant mode and by safety CPU

*3: Q_{UD}VCPU only.

*4: When using CW Workbench

*5: Does not support QnUDVCPU and certain models

*6: Does not support L02SCPU(-P)

*7: Supports the user Ethernet port of Q24DHCCPU-V/VG/LS and Q26DHCCPU-LS only

*8: Supports Q_{UDE}(H)CPU and Q_{UD}VCPU only

*9: Does not support Q_{UDE}(H)CPU and Q_{UD}VCPU

*10: Supports L02SCPU(-P) only

*11: Supports FX3S only

Programmable Controller
MELSEC iQ-R Series



MELSEC iQ-R
series

Bridging the next generation of automation

iQ Platform

Revolutionary, next-generation controllers building a new era in automation

To succeed in highly competitive markets, it's important to build automation systems that ensure high productivity and consistent product quality. The MELSEC iQ-R Series has been developed from the ground up based on common problems faced by customers and rationalizing them into seven key areas: Productivity, Engineering, Maintenance, Quality, Connectivity, Security and Compatibility. Mitsubishi Electric is taking a three-point approach to solving these problems: Reducing TCO*1, increasing Reliability and Reusability of existing assets. As a bridge to the next generation in automation, the MELSEC iQ-R Series is a driving force behind revolutionary progress in the future of manufacturing.

*1: Total Cost of Ownership

Process

 **High-availability process control in a scalable automation solution**

- Extensive visualization and data acquisition
- High-availability across multiple levels
- Easier maintenance and programming with integrated engineering software

Intelligence

 **Extensive data handling from shop floor to business process systems**

- Direct data collection and analysis
- C/C++ based programming
- Collect factory data in real-time
- Expand features using third party partner applications

Productivity

 **Improve productivity through advanced performance/ functionality**

- New high-speed system bus realizing shorter production cycle
- Super-high-accuracy motion control utilizing advanced multiple CPU features
- Inter-modular synchronization resulting in increased processing accuracy

Engineering

 **Reducing development costs through intuitive engineering**

- Intuitive engineering environment covering the product development cycle
- Simple point-and-click programming architecture
- Understanding globalization by multiple language support

Maintenance

 **Reduce maintenance costs and downtime utilizing easier maintenance features**

- Visualize entire plant data in real-time
- Extensive preventative maintenance functions embedded into modules

Quality

 **Reliable and trusted MELSEC product quality**

- Robust design ideal for harsh industrial environments
- Improve and maintain actual manufacturing quality
- Conforms to main international standards

Safety

 **System design flexibility with integrated safety control**

- Integrated generic and safety control
- Consolidated network topology
- Complies with international safety standards

Connectivity

 **Seamless network reduces system costs**

- Seamless connectivity within all levels of manufacturing
- High-speed and large data bandwidth ideal for large scale control systems
- Easy connection of third-party components utilizing device library

Security

 **Robust security that can be relied on**

- Protect intellectual property
- Unauthorized access protection across distributed control network

Compatibility

 **Extensive compatibility with existing products**

- Utilize existing assets while taking advantage of cutting-edge technology
- Compatible with most existing MELSEC-Q Series I/O

■ Key features/functions

Line manufacturing	Machine control	Distributed control	Small-scale I/O control	Large-scale I/O control	Space/cost saving	Security
Inter-modular sync	Built-in database	Integrated network	Multiple CPU	Process control	High-reliability control	Extensive built-in functions
C programming	Data logging	IT gateway	Motion control	Advanced motion	Safety	Real-time monitor



For further details, please refer to the "MELSEC iQ-R Series iQ Platform-compatible PAC" or "MELSEC iQ-R Series iQ Platform-compatible PAC (Concise)" catalog.

L(NA)08298ENG, L(NA)08293ENG

Advanced performance/functions improve productivity

Integrating high-performance capabilities based on the high-end iQ-R system bus, high-speed network, and an advanced motion control system; applications requiring these characteristics can be easily realized using the MELSEC iQ-R Series as the core of the automation system.

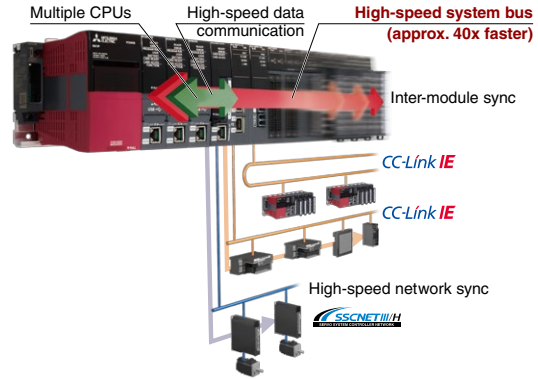

Built-in database eliminates the need for a PC-based database server

Recipe data and production results data, previously managed using a database server, can now be managed via the database in the programmable controller. Use of dedicated commands for the built-in database makes it easy to search, add and update data on the fly.



Powerful security features protecting intellectual property

Functions such as hardware security key identification for protecting programs and an IP filter for preventing unauthorized access to the control system through the network are incorporated to protect customers intellectual property whilst ensuring secure and safe control throughout the plant.



Intuitive and easy engineering

With GX Works3 graphic based programming cannot be made any easier with various intuitive features such as graphic based system configuration, and an extensive module library provided as standard. In addition to multiple language support realizing a global engineering tool required for current automation needs.

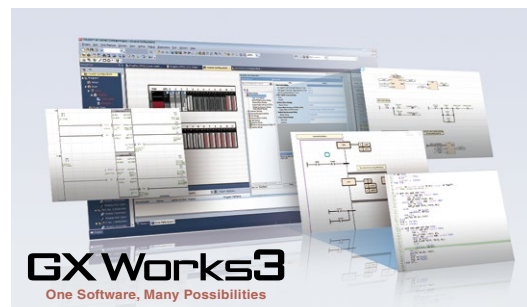

A wide range of modules supporting various different applications

The MELSEC iQ-R Series is a modular control system equipped with various modules such as CPUs, power supply, digital I/O, analog I/O and base unit and intelligent function modules, each having its own responsibility in the system. The core of the system is a base unit that interconnects all of the modules together and enables high-speed communications between each module. From small to large systems, scalability is simple. Up to seven extension bases can be connected and a maximum of 64 modules installed at any one time. An RQ extension base is also available, ensuring compatibility with existing MELSEC-Q Series modules.

R00CPU <small>NEW</small> Program capacity 10K steps	R04ENCPU Program capacity 40K steps, CC-Link IE embedded
R01CPU <small>NEW</small> Program capacity 15K steps	R08ENCPU Program capacity 80K steps, CC-Link IE embedded
R02CPU <small>NEW</small> Program capacity 20K steps	R16ENCPU Program capacity 160K steps, CC-Link IE embedded
R04CPU Program capacity 40K steps	R32ENCPU Program capacity 320K steps, CC-Link IE embedded
R08CPU Program capacity 80K steps	R120ENCPU Program capacity 1200K steps, CC-Link IE embedded
R16CPU Program capacity 160K steps	
R32CPU Program capacity 320K steps	
R120CPU Program capacity 1200K steps	

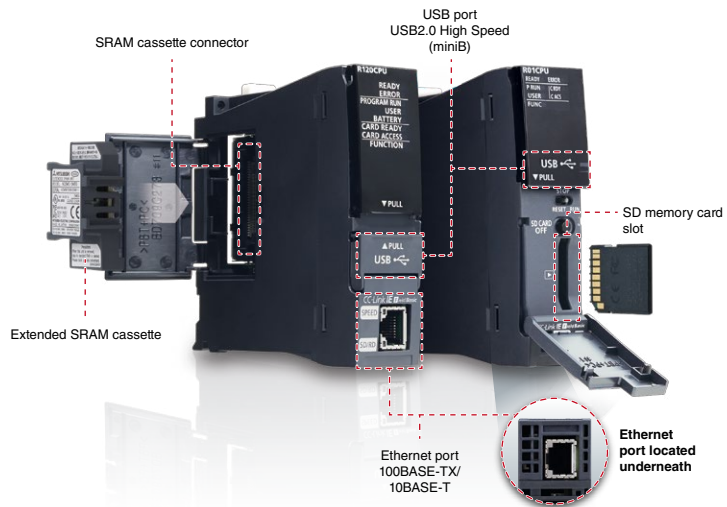

■ System configuration

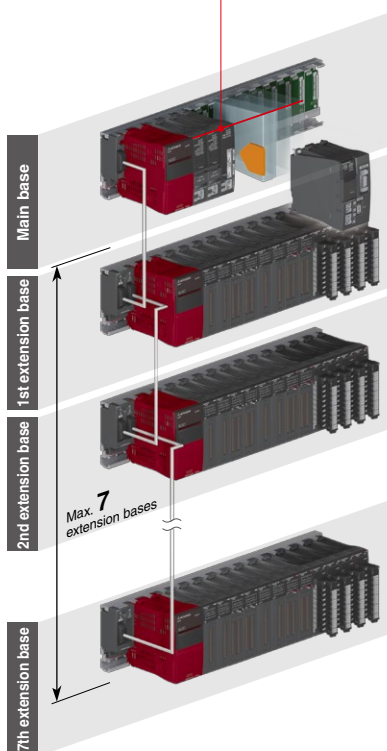

■ CPU modules

Install up to four CPU modules together

- Programmable controller CPU module
- CC-Link IE embedded CPU*1
- Motion CPU module
- Process CPU module
- SIL2 Process CPU module*2 NEW
- Safety CPU*3
- C Controller module

*1: Multi-CPU is not supported.

*2: Product package includes a SIL2 process CPU and SIL2 function module.

*3: Product package includes a safety CPU and safety function module.

■ Power supply module

- Power supply module



■ I/O & intelligent function modules

- Input module
- Output module
- I/O combined module
- Analog input module
- Analog input module (Channel isolation)
- Analog output module
- Analog output module (Channel isolation)
- Temperature input module
- Temperature control module
- Simple motion module
- Positioning module
- Flexible high-speed I/O control module

■ Base units

- Main base unit
- Extended temperature range main base

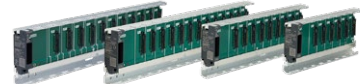

- Extension base unit
 - Extended temperature range extension base
- An extension base strictly for I/O and intelligent function modules.



- RQ extension base unit
- An extension base for MELSEC-Q Series modules (further extensions requiring the MELSEC-Q Series extension base version).



- High-speed counter module
- Ethernet interface module
- CC-Link IE Control network module
- CC-Link IE Field network master/local module
- CC-Link IE Field network remote head module
- AnyWireASLINK master module
- BACnet® module
- CANopen® module NEW
- CC-Link system master/local module
- Serial communication module
- MES Interface module
- OPC UA server module
- High-speed data logger module
- C intelligent function module

Integrated Safety control

The MELSEC iQ-R Series safety control system consists of a safety CPU that is compliant with international safety standards, ISO 13849-1 PL e and IEC 61508 SIL 3 and can execute both safety and general logic in the same CPU. The CPU module paired with the safety function module enables safety control and can be installed on a standard base unit realizing integration into an existing or new control system. Safety I/Os are controlled via CC-Link IE Field network connected to dedicated safety remote I/Os.

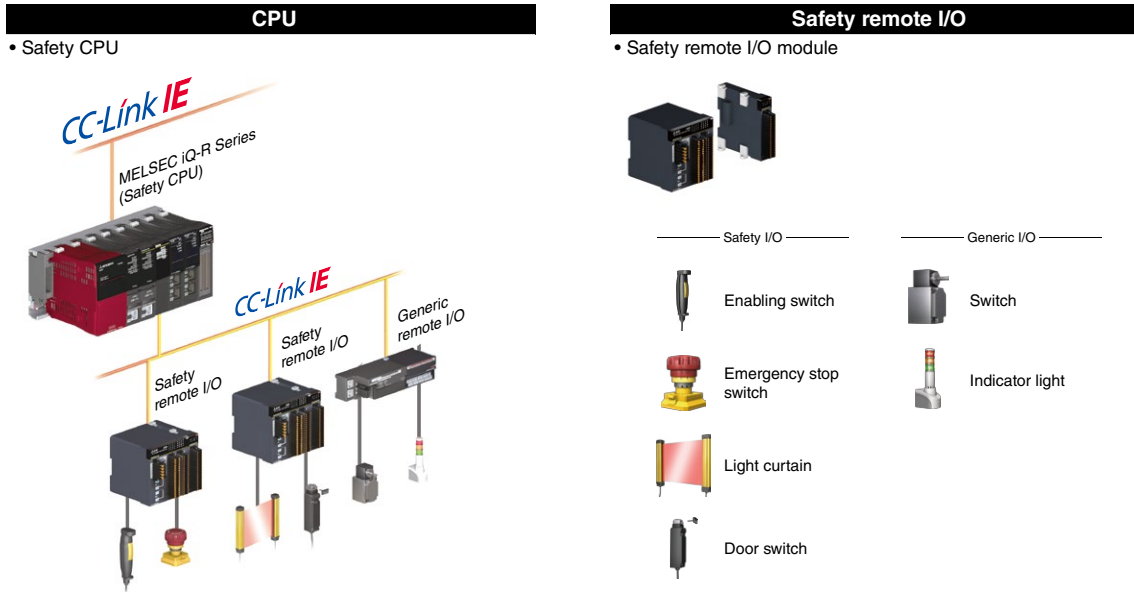

Highly-scalable redundant control

The MELSEC iQ-R Series redundant control system is based on a dual-system architecture where all modules on a primary system are duplicated onto a second or standby system with a tracking cable connecting the systems together. Both systems consist of the process CPU module and redundant function module, with the CPU module able to execute standard logic and process control. Remote I/O is controlled via the CC-Link IE Field network, and dedicated base units supporting redundant power supplies come in either standard or extended temperature models.

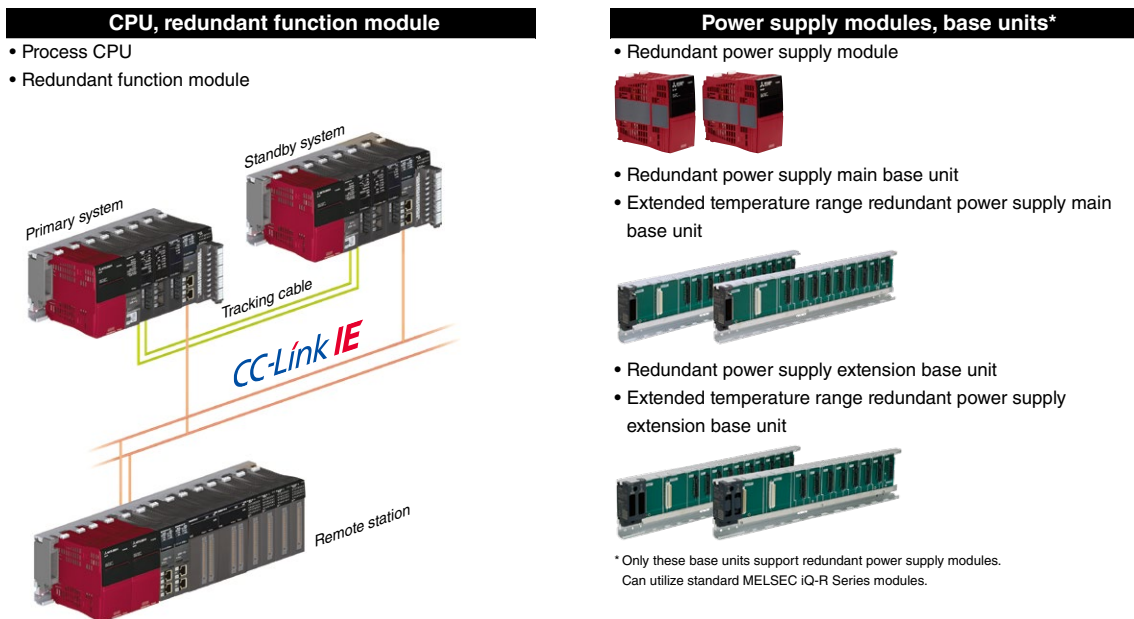

Highly accurate synchronization

The MELSEC iQ-R Series system provides highly accurate synchronization between modules on the control system which is realized through inter-modular synchronization. Additionally, use of the CC-Link IE Field Network realizes network-level synchronization, providing node-level synchronization that ensures deterministic data flow void of any influence from data transmission delays. This is ideal for applications such as “cutting and folding” inside an offset printer, which requires synchronization between the printing quality sensor, high-speed rotary cutter, folding roller and conveyor.

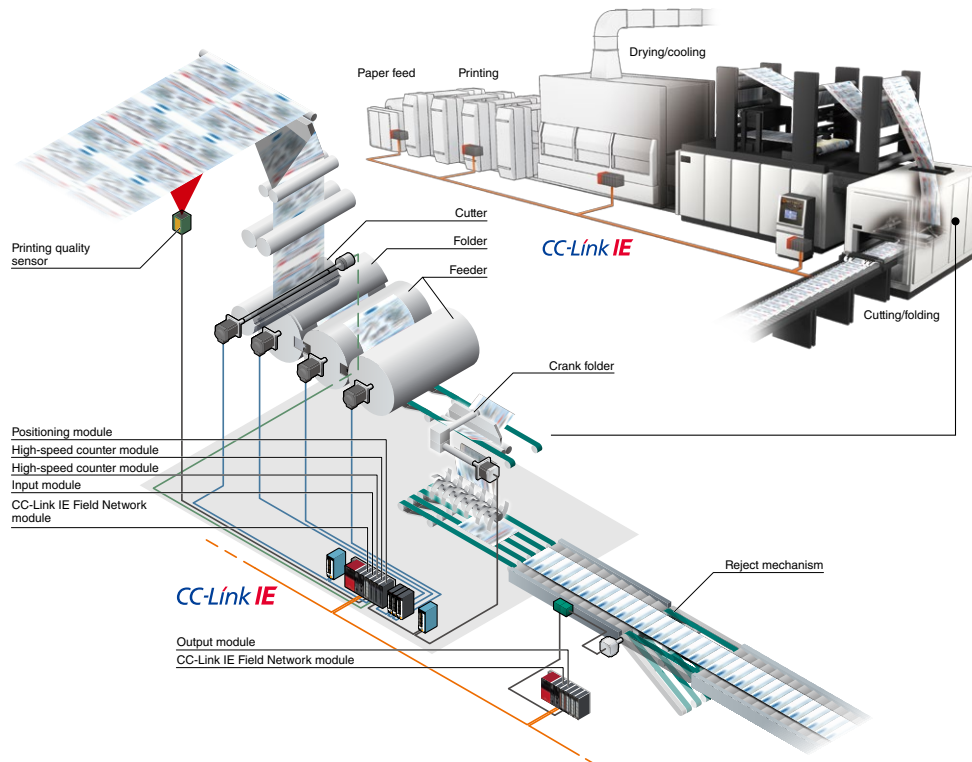

Flexible, large-capacity data storage

The MELSEC iQ-R Series programmable controller CPU is designed to allow an external SRAM cassette to be installed directly into the CPU module. This option makes it possible to increase internal device memory to an impressive 5786K words, expanding device/label memory even further. An SD memory card can be used at the same time, expanding data logging memory and the capacity of the internal database, which is ideal for large-scale systems. In general, management of programmable controller internal data is quite flexible, making programming even easier by allowing various data area allocations to be changed within the CPU memory and SRAM cassette.

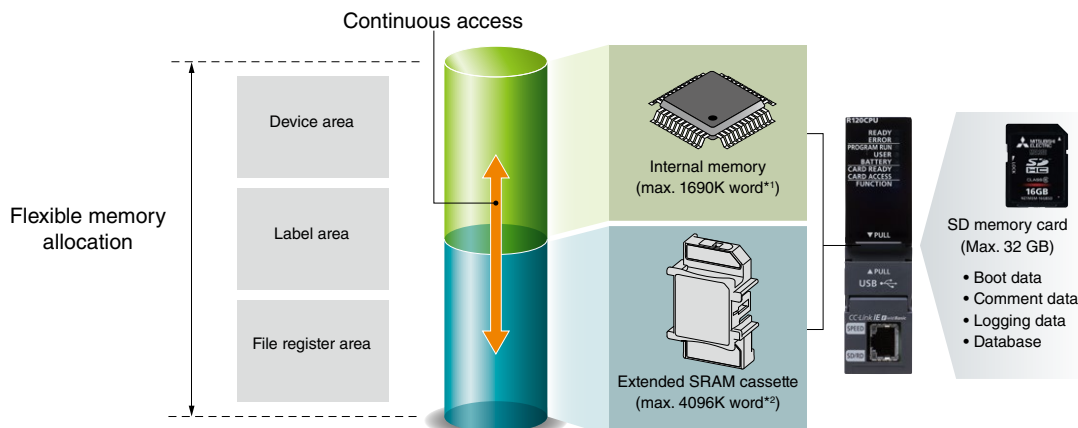

*1: Based on R120CPU.

*2: Based on NZ2MC-8MBS (8 MB).

Data management utilizing internal database (DB)

The CPU includes an internal database that can be installed into the SD memory card. This feature allows, for example, a selection of database commands that can add/delete/change records to be utilized for simple recipe functions. It is also much easier to import/export Unicode files for use in spreadsheets. This is a very useful feature, especially for the food and beverage industry where multiple product variations are produced using the same machine process.

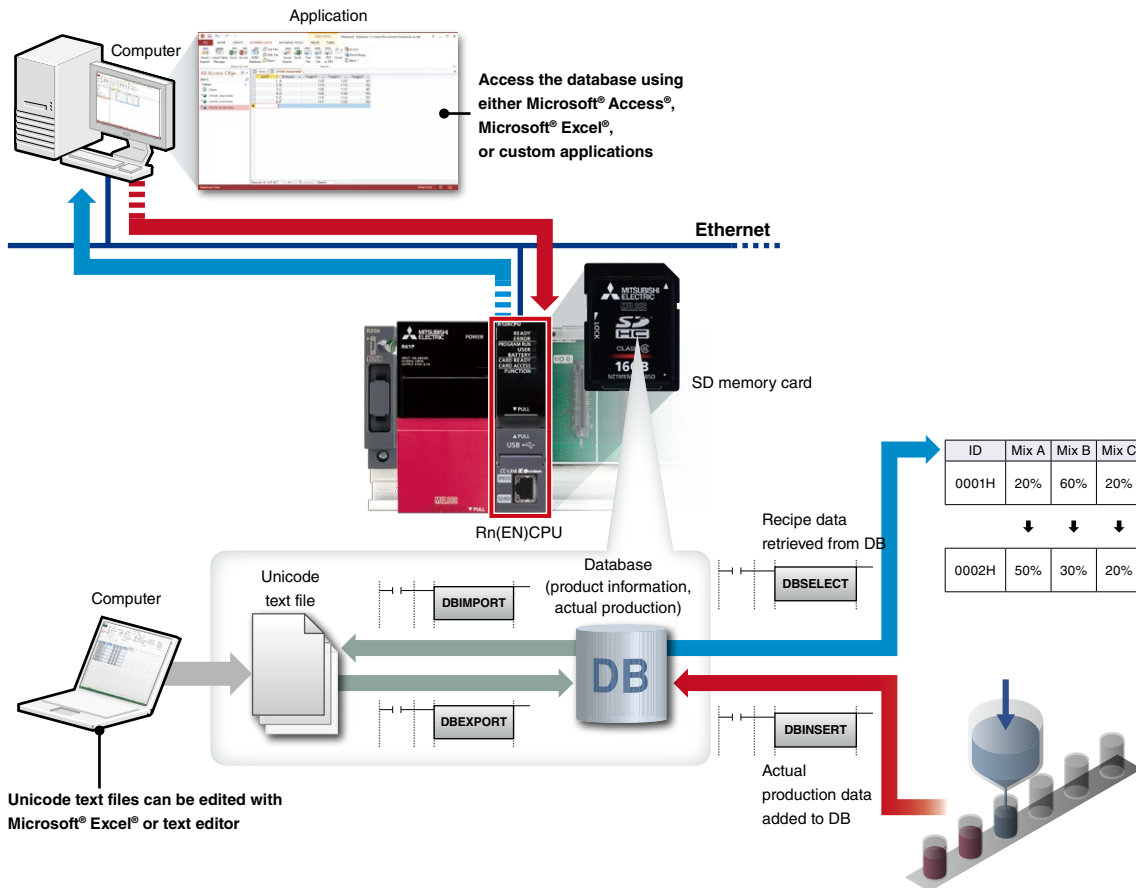

Intuitive root cause analysis

When the SD memory card is installed, device data is saved automatically to the SD memory at the time of system failure. This data is useful for investigating the cause of the failure, enabling various data collected before and during the event to be analyzed. The data can be used in a situation such as when the origin of a machine is different than where the machine was actually being used, and the data can simply be sent by e-mail (for example) as a data file for analysis.

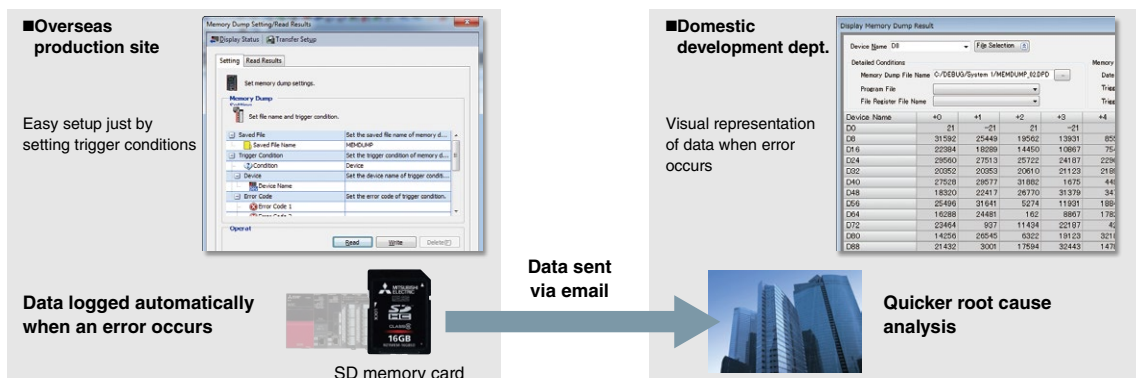

MELSEC-Q Series



MELSEC Q series

Model flexibility supports versatile applications and improved productivity



Multi-discipline design offers a broad spectrum of automation controllers

Current production requirements are calling for an increase in productivity and carrying out production processes even faster due to an increase in production information such as production results and traceability. The MELSEC-Q Series programmable controller “Universal Model QnU” is ideal for these market needs. High-speed basic instruction processing dramatically increases control system and machine performance. Inheriting the highly robust and easy-to-use design of the Q Series, the MELSEC QnU programmable controller opens up new possibilities in automation.

Program capacity (step)

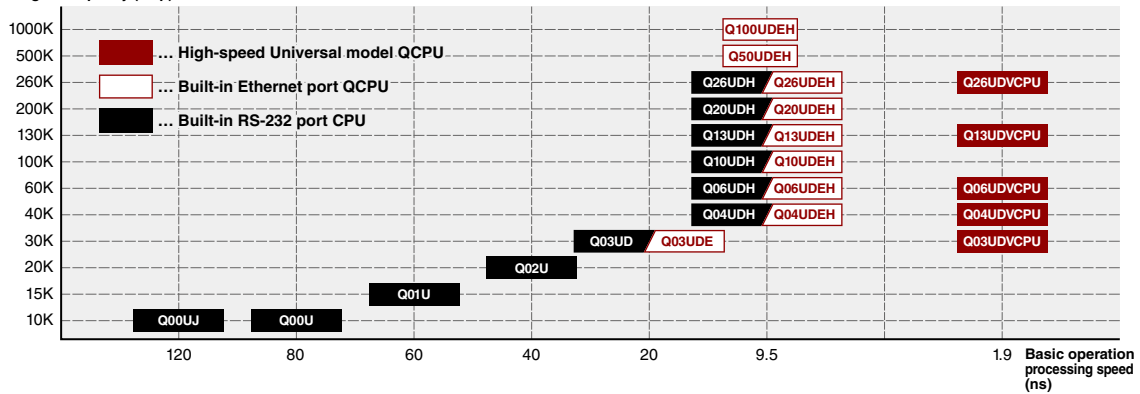

System configuration

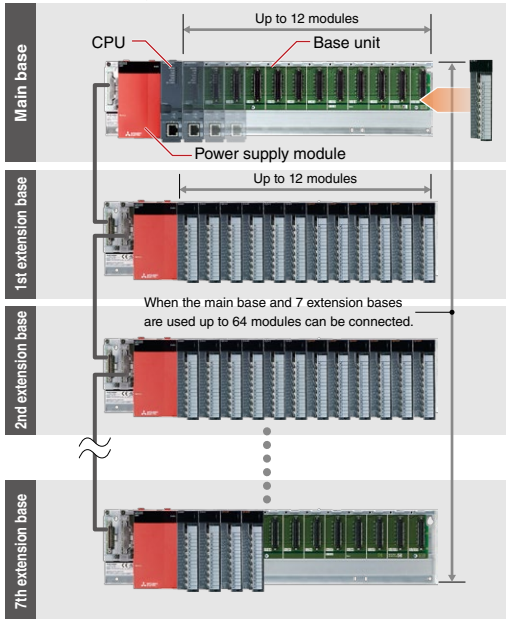

CPU modules

- Install up to four CPU modules together*2
- Programmable controller CPU
- Motion CPU
- Process CPU
- Redundant CPU
- C Controller
- Robot controller
- CNC CPU

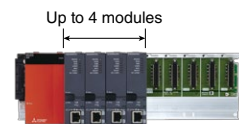

The 2nd and subsequent CPUs can be installed using slots No. 0 to 2

Base units*3



- Main base (3, 5, 8, 12)
- Multiple CPU high-speed main base (5, 8, 12)
- Slim type main base (2, 3, 5)
- Redundant power main base (8)
- Extension base (2, 3, 5, 8, 12)
- Redundant power extension base (8)
- Redundant type extension base (5)

Power supply modules



- Power supply
- Power supply with life function
- Slim type power supply
- Redundant power supply

I/O & intelligent function modules



- I/O module
- Interrupt module
- Analog I/O module
- Load cell input module
- CT input module
- Temperature input module
- Temperature control module
- Loop control module
- Simple motion module
- Positioning module
- High-speed counter module
- Channel isolated pulse input module
- Energy measuring module
- Isolation monitoring module
- MES interface module
- High-speed data logger module
- Web server module
- Intelligent communication module
- Network module

*1: The maximum number of modules that can be installed depends on the CPU configuration.
 *2: Except redundant CPU.
 *3: The number within brackets is the number of slots.

■ Key features/functions

Line manufacturing	Machine control	Distributed control	Small-scale I/O control	Large-scale I/O control	Space/cost saving	Security
Inter-modular sync	Built-in database	Integrated network	Multiple CPU	Process control	High-reliability control	Extensive built-in functions
C programming	Data logging	IT gateway	Motion control	Advanced motion	Safety	Real-time monitor



For further details, please refer to the "Programmable Controllers MELSEC-Q series [QnU]" catalog.

L(NA)08101E

High-speed, high-accuracy machine control

To achieve truly high-speed synchronized control between multiple CPUs, a dedicated bus is used, independent of sequence program operation (0.88 ms operation cycle)*1 This multiple CPU high-speed communication is synchronized with motion control to maximize computational efficiency. Additionally, the performance of the motion control CPU is twice as fast as the previous model, ensuring high-speed, high-accuracy machine control.

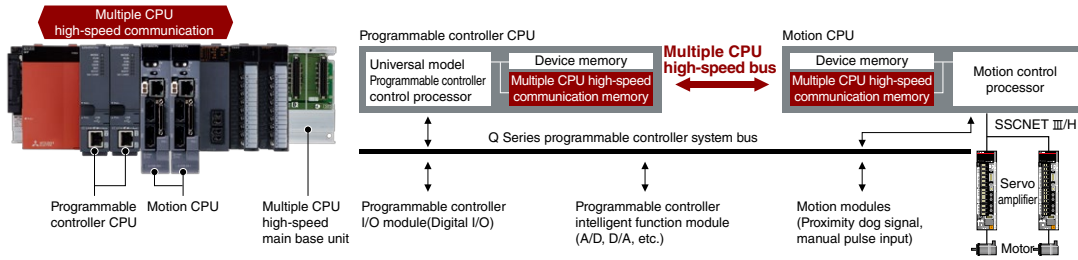

*1: Q00UJ, Q00U, Q01U, and Q02U are not supported.

Large data volume at high-speed

Conventionally, continuous access to the standard RAM and SRAM card's file register area could not be achieved which had to be reflected in the user program. When an 8 MB extended SRAM cassette*2 is installed in the High-Speed Universal model QCPU, the standard RAM can be as one continuous file register with up to 4736K words capacity, simplifying the user program. Even if device memory is insufficient, the file register area can be expanded easily by installing an extended SRAM cassette.

High-speed Universal model QCPU

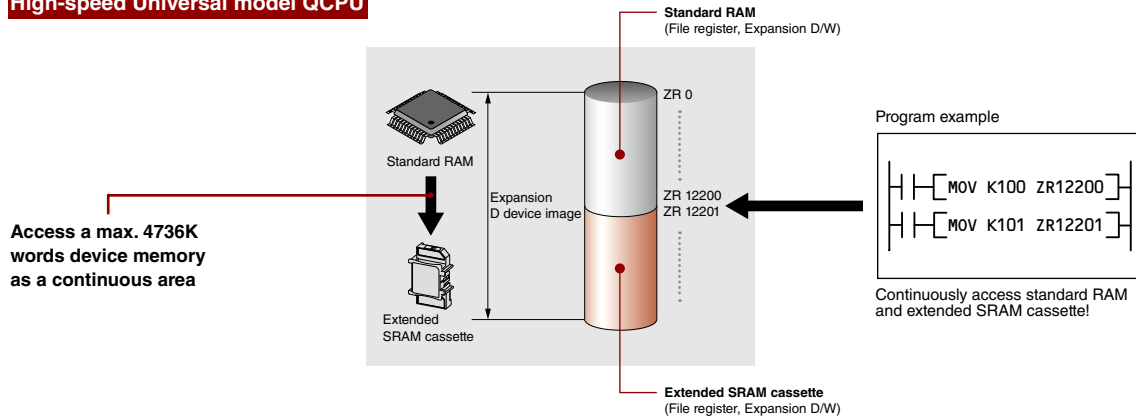

*2: Only supported by Q03UDV, Q04UDV, Q06UDV, Q13UDV, and Q26UDV.

Easy logging without a program*3

Logging can be easily performed using the Wizard setting tool. The data collected can be saved in CSV format on an SD memory card and be displayed on a computer or GOT (HMI). Various reference materials including daily and general reports can be created easily using the saved CSV file. This data can be used for a wide variety of applications requiring traceability, production data, etc.



Logging data display and analysis tool GX LogViewer



GOT (HMI) log viewer function

*3: Supports Q03UDV, Q04UDV, Q06UDV, Q13UDV, and Q26UDV.

MELSEC-L Series



MELSEC *L* series

Amazingly small footprint and loaded with high-performance features

Convenience that fits in the palm of your hand

The L Series is a compact-class controller, part of the MELSEC products renowned for exceptional cost verses performance and strong reliability. It provides the performance, functions, and capabilities required for today's demanding applications in a small package. MELSEC-L Series greatly expands the range of functionality traditionally associated with compact programmable controllers and through user-centric design, pushes the limits of ease of use.

Program capacity (step)

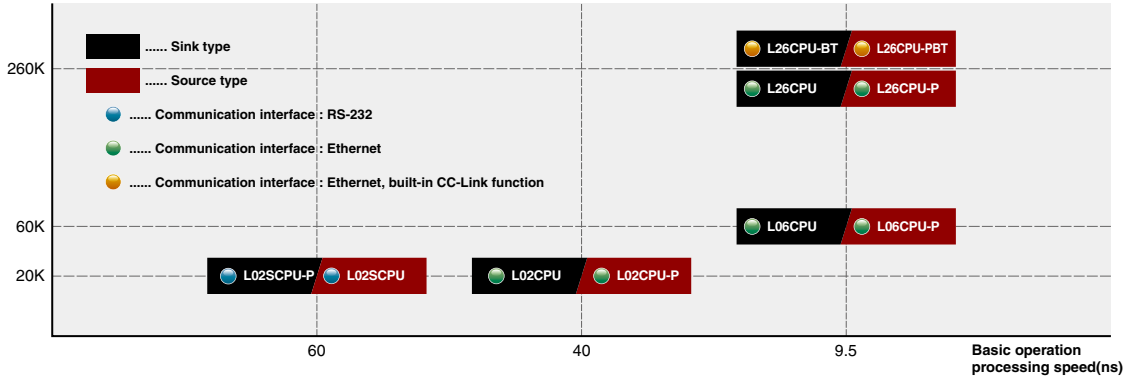

Example of largest system configuration with L26CPU-BT

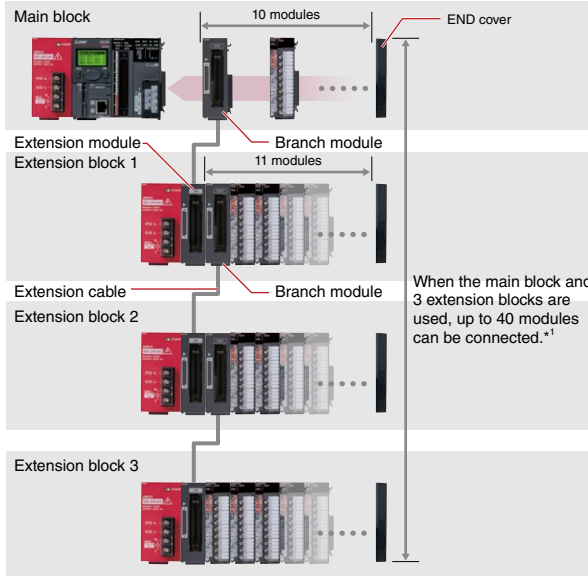

■ CPU module

- Programmable controller CPU (sink type/source type)
- Built-in communication interface
 - ▶ RS-232
 - ▶ Ethernet
 - ▶ Ethernet + CC-Link

■ Option

- Display unit
- RS-232 adapter
- RS-422/485 adapter
- Battery
- SD/SDHC memory card

■ Power supply modules

- Power supply module
- Power supply module (slim type)

■ Branch/extension modules

- Branch module
- Extension module

■ Modules

- I/O module
- Analog module
- Multiple input (voltage/current/temperature) module
- Temperature input module
- Temperature control module
- Simple motion module
- Positioning module
- High-speed counter module
- Flexible high-speed I/O control module
- Network module

CPU module*2	Number of extension blocks	Number of supported modules*3
L02SCPU(-P) L02CPU(-P)	Up to 2	Main block: 10 Extension block: 11
L06CPU(-P) L26CPU(-P) L26CPU(-P)BT	Up to 3	

*1: Total number of I/O, intelligent function, and network modules. Does not include branch module.

*2: CPU modules whose first five serial number digits are 13072 or later.

*3: Total number of I/O, intelligent function, network, and branch modules. Does not include power supply module, CPU module, display unit, extension module, RS-232 adapter, RS-422/485 adapter and END cover.

■ Key features/functions

Line manufacturing	Machine control	Distributed control	Small-scale I/O control	Large-scale I/O control	Space/cost saving	Security
Inter-modular sync	Built-in database	Integrated network	Multiple CPU	Process control	High-reliability control	Extensive built-in functions
C programming	Data logging	IT gateway	Motion control	Advanced motion	Safety	Real-time monitor



For further details, please refer to "Programmable Controllers MELSEC-L series" catalog. L(NA)08159E

Various built-in I/O features and communication interfaces come as standard

In its compact body, a large variety of I/O features are built in as standard. Due to an abundance of advanced functionality, L Series CPUs are flexible enough to meet a wide variety of needs. With a display unit enabling routine operation without a computer, an SD memory card, and easy-to-use programming environment, the L Series dramatically improves system designing and system operation and contributes to improve work efficiency. The display unit*1 shows system statuses and enables setting changes to be made without a program. Even when an error occurs, the error status can be easily checked, assisting troubleshooting on-site.

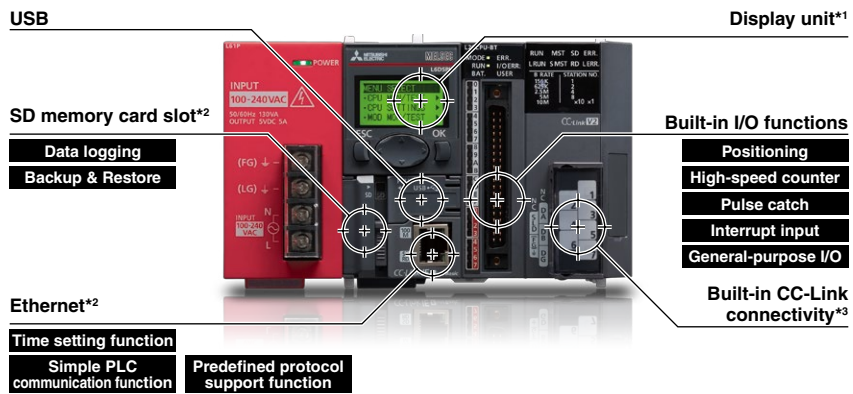

*1: Option (sold separately). Not compatible with L02SCPU (-P).
 *2: Supports L02CPU (-P), L06CPU(-P), L26CPU(-P), L26CPU(-P) BT.
 *3: Supports L26CPU(-P) BT.

Gain more flexibility with an integrated system bus structure

L Series modules do not require a base unit. Having an integrated system bus structure, the L Series can be attached directly to a DIN rail by using the minimal required space. Furthermore, adding modules to the system is not restricted by the number of available base unit slots, and costs may be reduced due to the elimination of extension base units.



Improved debugging for system startup and troubleshooting

Device values in the CPU can be monitored in real-time with a detailed setting including interval and timing. Additionally, changes in the device value can be monitored within the GX LogViewer trend graph and are exportable to a computer for further analysis.

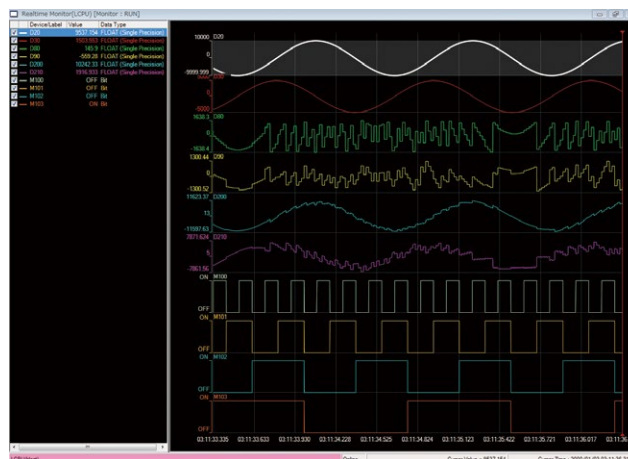



MELSEC iQ-F Series

MELSEC iQ-F series

The next level of industry



New micro PLC designed on the concept of ...



- ▶ Completely redesigned, high-speed system bus
- ▶ Extensive built-in functions
- ▶ Enhanced security functions
- ▶ No internal battery required
- ▶ Built-in positioning (4-axis 200 kpps)
- ▶ Simple linear interpolation
- ▶ 4/8-axis synchronous control with simple motion module (Dedicated positioning software not required)
- ▶ Easy programming by drag and drop
- ▶ Reduced development time with module FB
- ▶ Parameterized setup for a variety of functions

■ System configuration

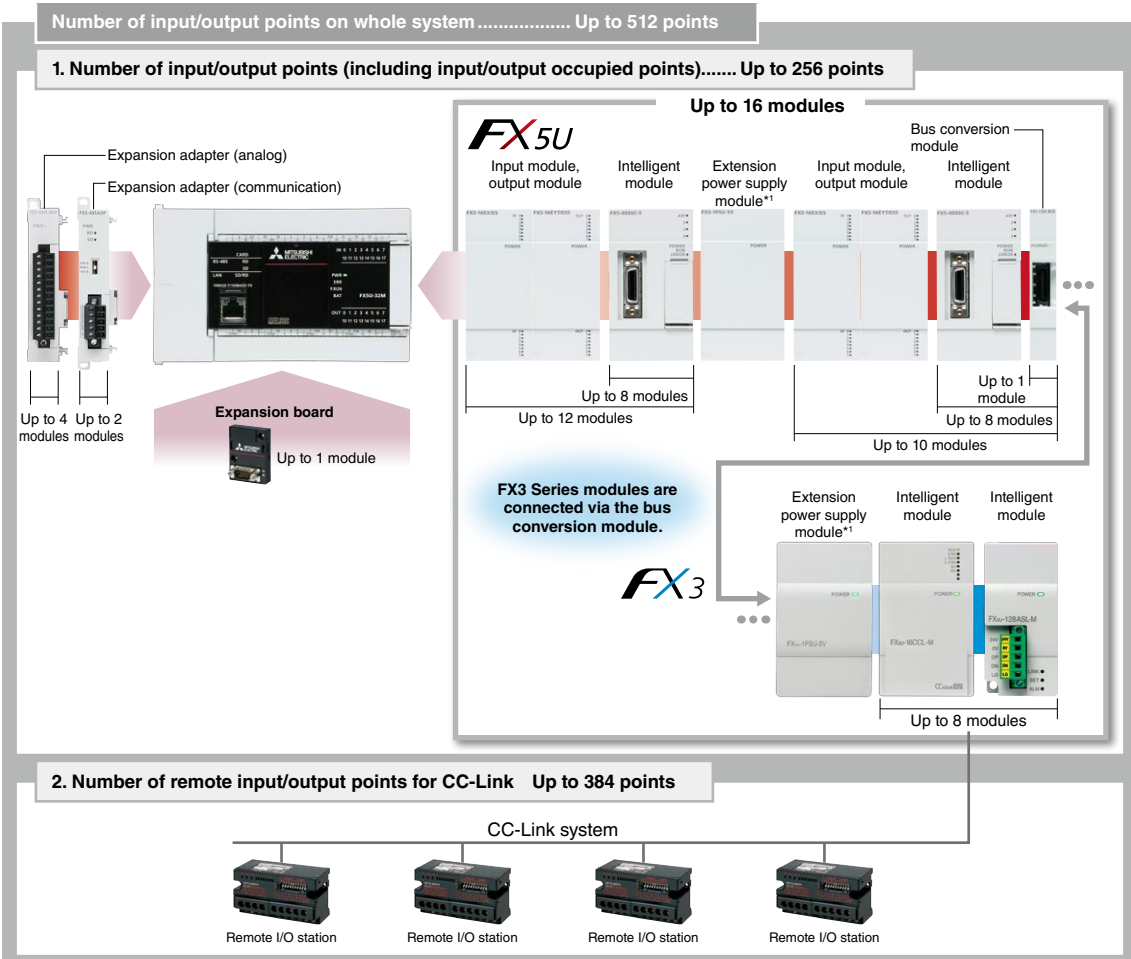

*1: Up to two extension power supply modules are connectable.

■ Key features/functions

Line manufacturing	Machine control	Distributed control	Small-scale I/O control	Large-scale I/O control	Space/cost saving	Security
Inter-modular sync	Built-in database	Integrated network	Multiple CPU	Process control	High-reliability control	Extensive built-in functions
C programming	Data logging	IT gateway	Motion control	Advanced motion	Safety	Real-time monitor



For further details, please refer to the "MELSEC IQ-F Series IQ Platform-compatible PLC" catalog.

L(NA)08428ENG

Integrated functions

The high-speed system bus realizes faster communications speed of up to 150 times*1, increasing overall machine performance. The CPU module has many integrated features (Ethernet, RS-485 (MODBUS®RTU supported), analog I/O*2, SD memory card slot, etc.) providing greater flexibility and helping to reduce system costs.

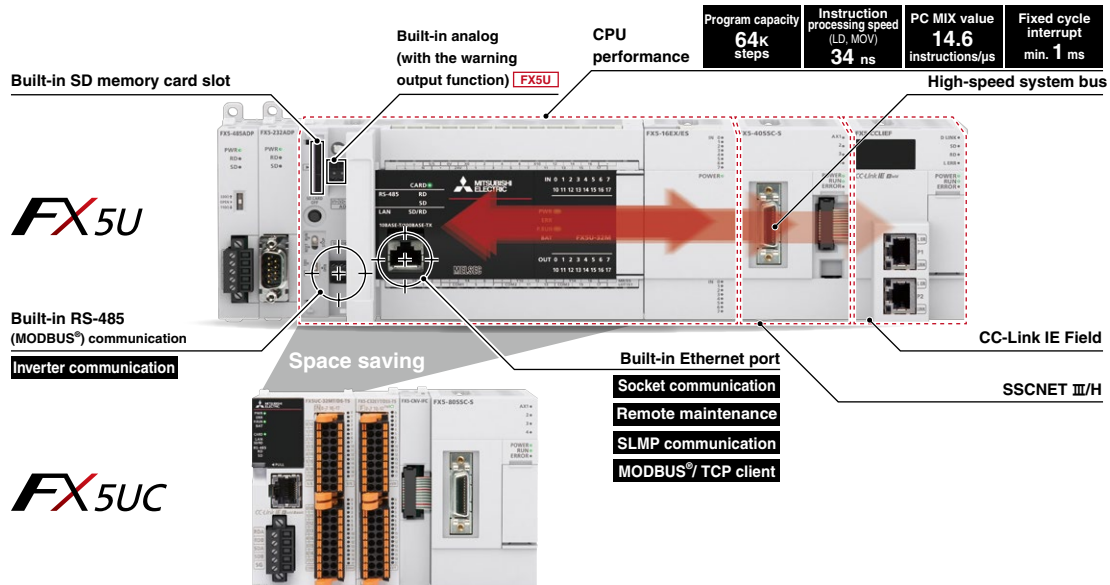

*1: Compared to FX3U Series.
*2: Not available in FX5UC.

Easy parameter setup

With the MELSEC IQ-F, setting of parameters has been made even easier by the integration of parametrization functionality into GX Works3 engineering software. Setting of parameters for built-in functions, external devices, and program execution trigger are simply done.

- Settable parameters**
- CPU parameters, Ethernet port, RS-485 communication port, I/O response time, expansion board, memory card, security key functions, etc.
 - Expansion adapter, intelligent function module settings

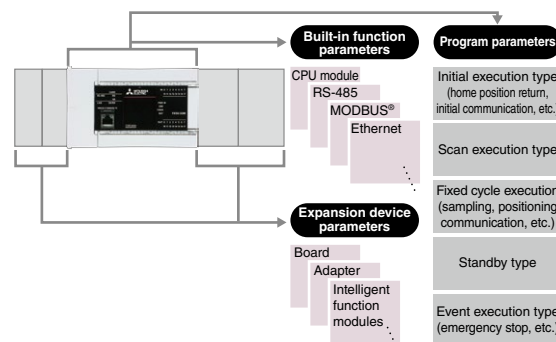

Standard function/function blocks

Approximately 110 types of standard function and functions blocks are available to utilize in the control program.

These functions/function blocks are conveniently located as parts library further helping to reduce overall engineering time.

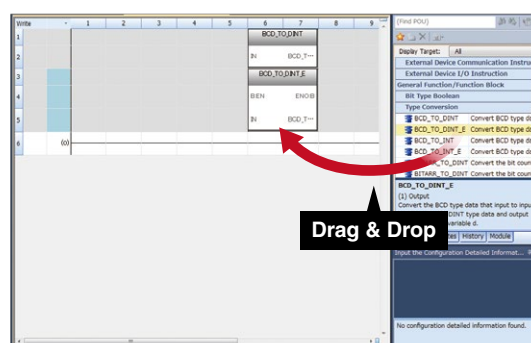

Positioning solution

Built-in positioning (200 kpps, 4-axis built-in)

- Positioning that support 20 μ s high-speed startup

FX5U/FX5UC features powerful positioning functionality with 8-channel high-speed pulse inputs and 4-axis pulse outputs. Positioning operations including interrupt, variable speed, and simple interpolation, and can easily be set up using tables.

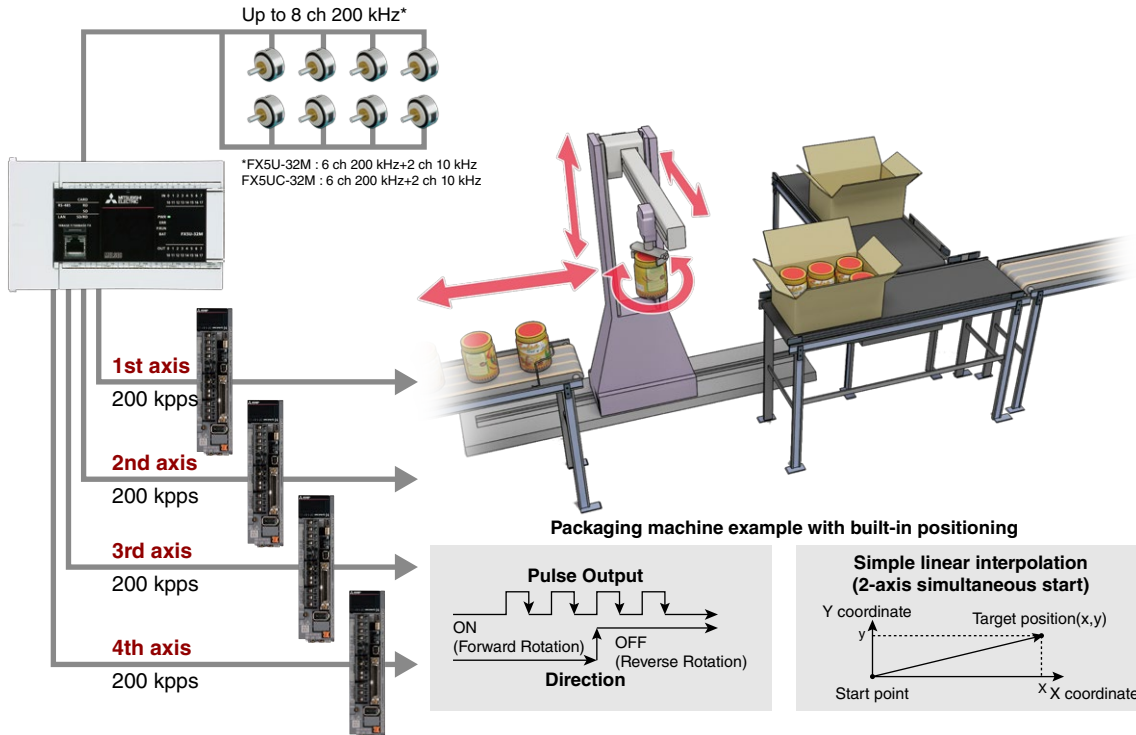

Simple motion module (4/8-axis control module)

- Positioning control via SSCNET III/H

Simple motion module is equipped with a 4/8-axis positioning function compatible with SSCNET III/H. By combining linear interpolation, 2-axis circular interpolation and continuous trajectory control in the program set with a table, a smooth trajectory can be easily drawn.

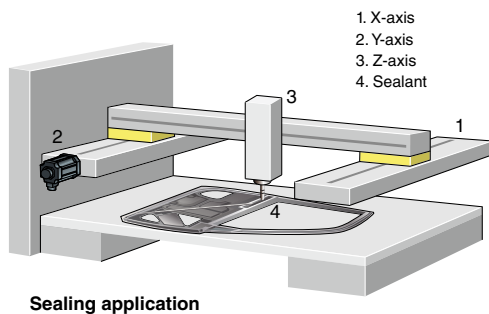

Main functions

- Linear interpolation
- Circular interpolation
- Continuous trajectory control
- S-curve acceleration/deceleration

Application examples

- Sealing
- Palletizer
- Grinding machine



Advanced motion control

Making Simple Motion with compactly packed extra functions

Similar to positioning modules, simple motion modules are capable of a wide range of high-precision control such as positional control, advanced synchronous control, cam control, and speed-torque control with setup being done easily by parameters and programming.

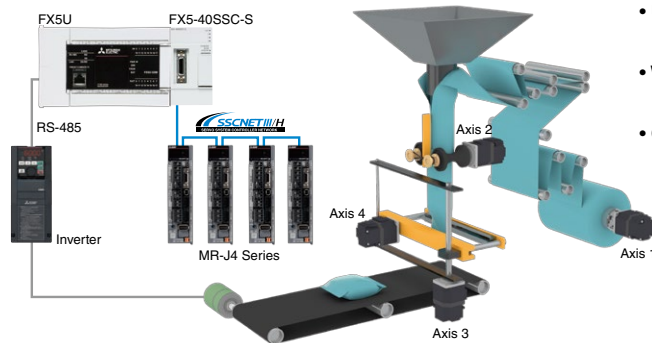

Packing machine example with Simple Motion

- Use synchronous control and cam functionality to make systems that work continuously and maximize output.
- With 64 cam profiles available, the same machine can be used for many different packing styles.
- Continuous operation without stopping the movement of the work piece

Advanced synchronous control

Software-based synchronous control can be used as an alternative to mechanical control, such as gear, shaft, transmission and cam. In addition, cam control is even easier with cam auto-generation. Synchronous control can be simply performed (start/stop) for each axis, allowing synchronous and positional control axes within the same program. Up to 4 control axes*1 can be synchronized when using the synchronous encoder, such as that used for packing machines, for example.

*1: FX5-80SSC-S supports up to 8-axis control.

Cam auto-generation

Cam data for a rotary cutter can be generated automatically simply by registering the sheet length, synchronization width, rotary cutter axis dimension, etc.

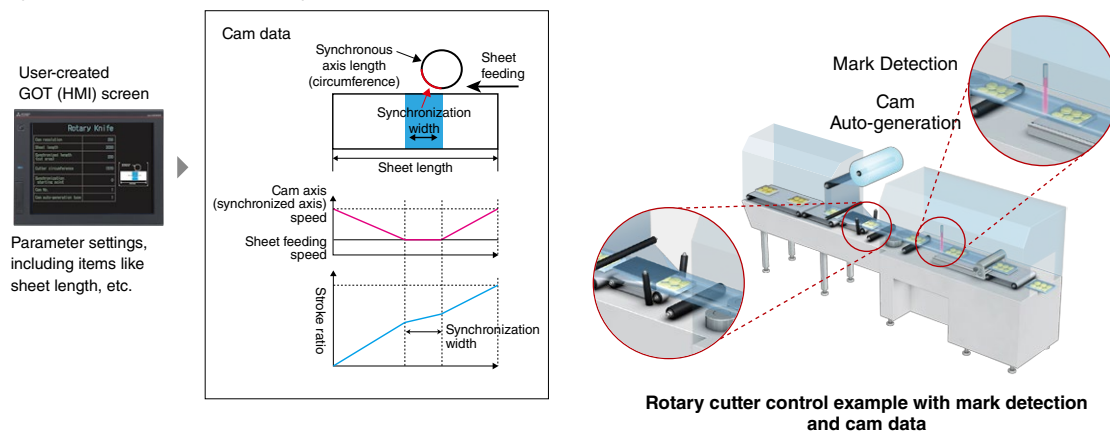

Rotary cutter control example with mark detection and cam data

Mark detection

The actual position of the servo motor can be obtained based on the registration mark printed on the high-speed moving film. Compensation of the cutter axis position, based on the registration marks, keeps the constant cutting position.

MELSEC-F Series



MELSEC-F

All-in-one model
with built-in power supply, CPU, and I/O

The third generation of micro programmable controller, the FX3 Series

The FX Series is renowned for its speed, capacity, performance and extensive features. Integrated with many features including analog, communication, Ethernet, and positioning, the FX3 Series realizes high-performance in many different applications.

Program capacity (steps)

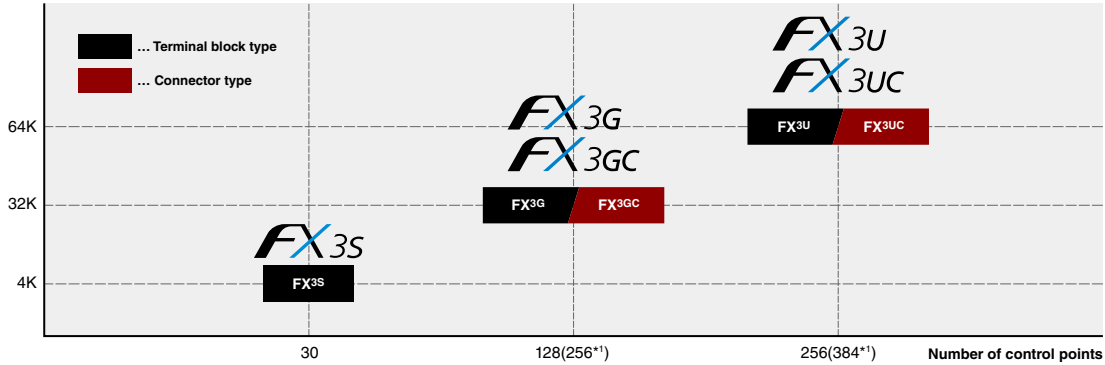

*1: Number of maximum I/O points including remote I/O.

System configuration



Main units



- FX3U/FX3UC
- FX3G/FX3GC
- FX3S

Special adapters



- Analog I/O
- Communication
- Data collection
- High-speed I/O

Expansion units



- I/O extension block
- Analog I/O block
- Temperature control block
- Temperature sensor input block
- Positioning control block
- Communication/network block
- Extension power supply unit

Expansion boards



- Communication
- Analog I/O
- 8-point variable analog potentiometer
- Extended I/O
- Special adapter connection

Options



- Display module
- Memory cassette
- Battery
- Extension cable
- Conversion adapter

*2: Connectable special adapters, extension units, expansion boards, and other options differ by the models. For details, please refer to the manual of the relevant product.

■ Key features/functions

Line manufacturing	Machine control	Distributed control	Small-scale I/O control	Large-scale I/O control	Space/cost saving	Security
Inter-modular sync	Built-in database	Integrated network	Multiple CPU	Process control	High-reliability control	Extensive built-in functions
C programming	Data logging	IT gateway	Motion control	Advanced motion	Safety	Real-time monitor



For further details, please refer to the "PROGRAMMABLE CONTROLLERS MELSEC-F FX Family Catalog"

HIME-B215

Extensive built-in functions

Including high-speed counter, positioning, high-speed I/O, communication ports, 24 V DC power supply, and other built-in functions, the main control unit can be easily connected with various different external control devices.



Combining with other Mitsubishi Electric factory automation products

In addition to its extensive built-in functions, the FX Series is highly scalable by being connectable to various different devices such as analog, positioning, communication networks, and sensor control through its expansion unit capability.

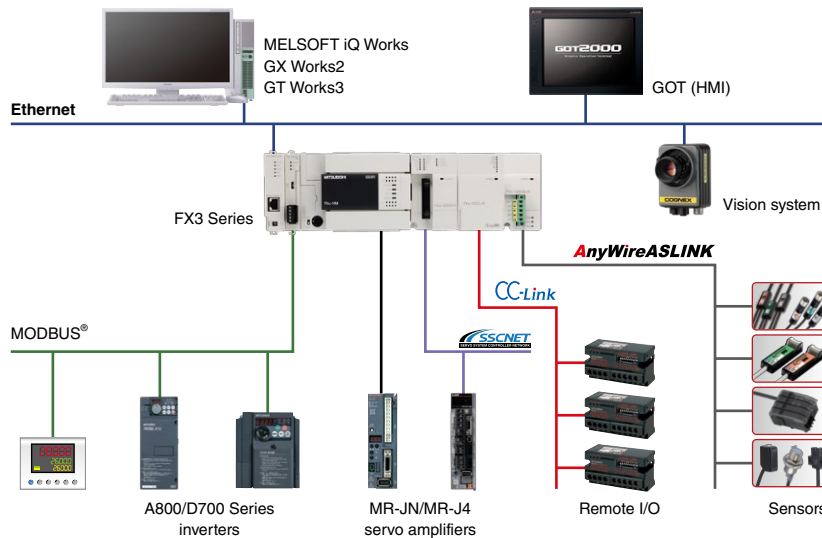

Compatibility

FX Series compatibility

The FX3 Series shares the same size with the FX1S, FX1N/FX1NC, and FX2N/FX2NC Series supporting various different extension blocks

Reusing the existing programs

The dedicated programming tool enables any existing program to be converted, just as simply by changing the PLC type.



Application-specific CPUs
MELSEC Safety



For further details, please refer to "Safety Programmable Controller/Safety Controller" catalog and "MELSEC iQ-R Series Safety CPU module, Safety Remote I/O module" Broadcast.

L(NA)08192E, R003ENG

MELSEC Safety iQ Platform

Integrated safety control on the shop floor

iQ-R series

Integrated safety control offering a total system solution

Ensuring the safety of personnel on the factory floor is a fundamental requirement of manufacturing plants and requires stringent safety regulations. To adhere to this safety code for control systems, the MELSEC iQ-R Series is equipped with a safety CPU that is compliant with international safety standards, enabling safety devices to be connected via the CC-Link IE Field network. The entire system can be programmed using GX Works3 programming software as standard.

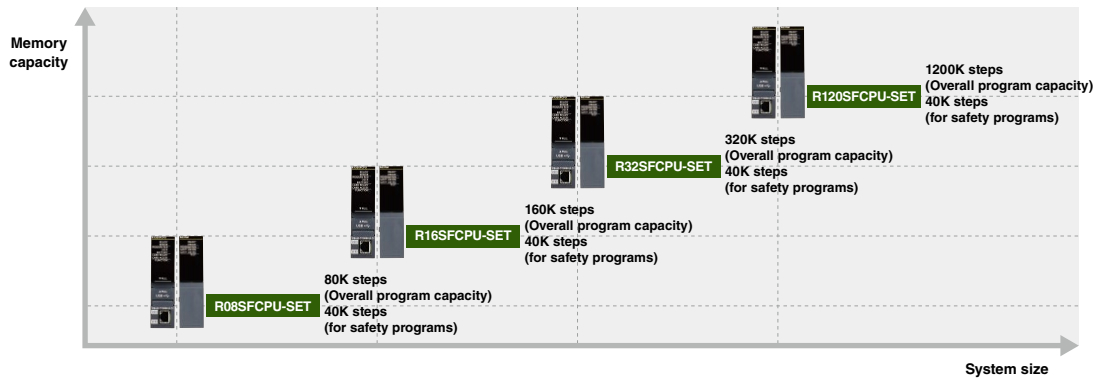

Safety communication on the same network

Establishing a safety communication is as easy as configuring a CC-Link IE Field network, which has the long-standing reputation as a versatile gigabit network. The physical layer and data communications is based on Ethernet technology and enables commercial cables, adapters, and hubs to be used. The safety communication also takes advantage of highly flexible features offered by CC-Link IE Field network.

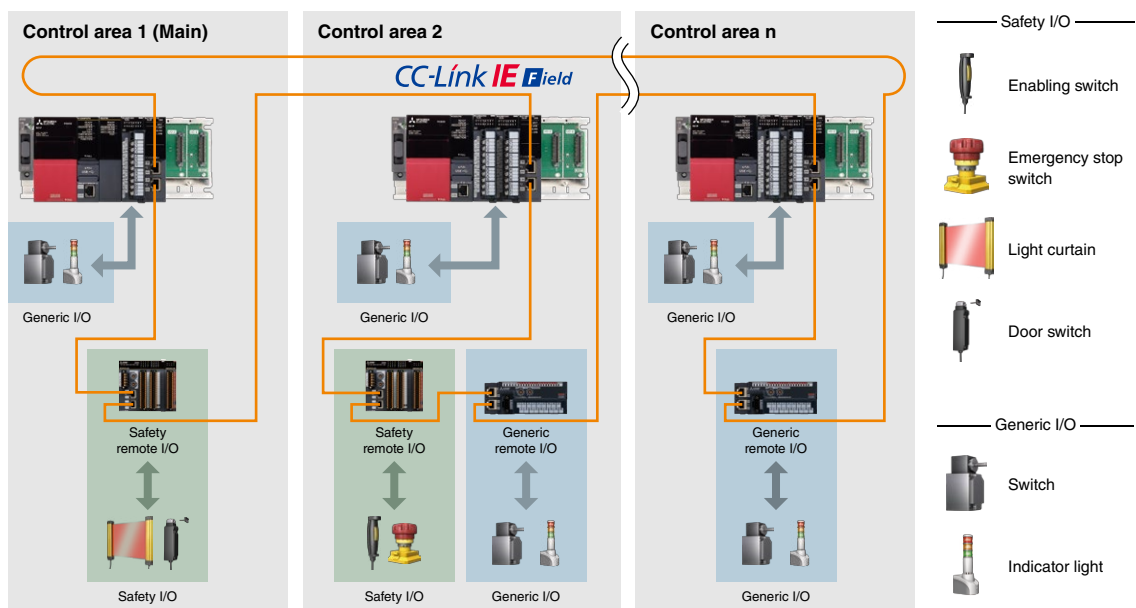



MELSEC Process Control



For further details, please refer to "MELSEC PROCESS CONTROL/REDUNDANT SYSTEM" catalog and "MELSEC IQ-R Series Process CPU/Redundant system" Broadcast.

L(NA)08030E, R007ENG

MELSEC PROCESS CONTROL *iQ* Platform

High-speed processing for full-scale monitoring and control

iQ-R series

Q series

Flexible process control in a cost-efficient automation control solution

The MELSEC process control system consists of a number of specialized controllers specifically designed for use in process automation such as petrochemical refinement and food/beverage production. The CPUs include a specialized set of proportional-integral-derivative (PID) algorithms, and are highly flexible utilizing standard automation control system features rather than highly-specialized distributed control system (DCS) solutions that can be costly to replace and maintain. The system is available in two types, general and high-reliability; the latter of which is in applications such as water treatment and waste incineration.

Discrete process control

Food processing equipment, semiconductor systems, air-conditioning equipment, industrial furnaces, etc.

Continuous process control

Factors unpredictable by Mitsubishi Electric; damages to products and to other duties. Chemical, steel, environmental and water treatment plants, DCS replacement, etc.

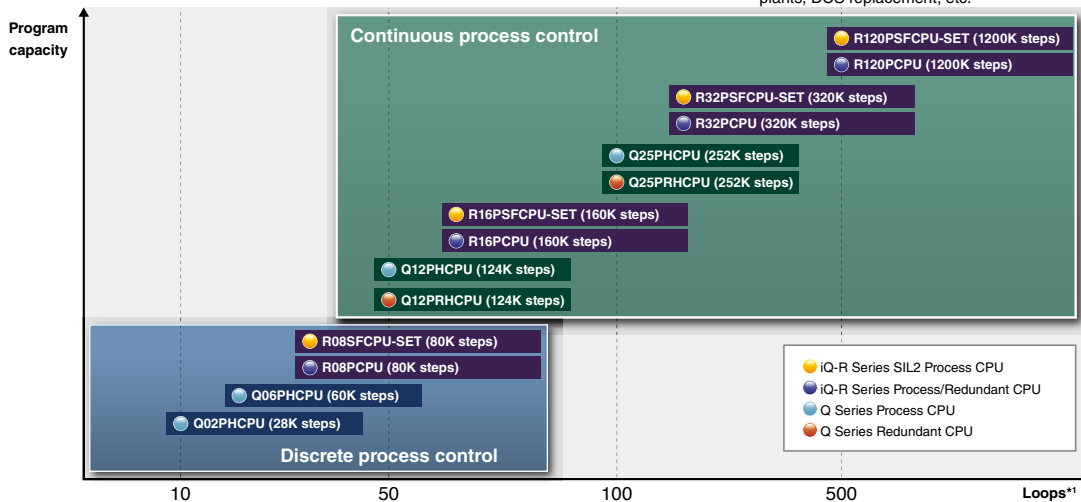

*1: The maximum amount of usable loops may change depending on the actual program size used. Please refer to the relevant manuals for further details.

The MELSEC iQ-R Series process CPU includes dedicated algorithms (such as two-degree-of-freedom PID, sample PI, and auto-tuning), and supports memory sizes of up to 1200K steps. In addition, when paired with a redundant function module, a highly reliable (redundant) control system can be realized. The SIL2 process CPU*2 also realizes a redundant system conforming to IEC 61508 SIL 2 safety standard. GX Works3 makes programming easier by being able to manage process control, safety and generic programs together. Transition from existing control systems based on MELSEC-Q Series is simpler by using the RQ extension base unit. The MELSEC-Q Series also enables loop control (similar to the MELSEC iQ-R Series), and realizes redundant control by using the redundant CPU (Q12PRH/Q25PRHCPU).

*2: Only supports redundant control system.

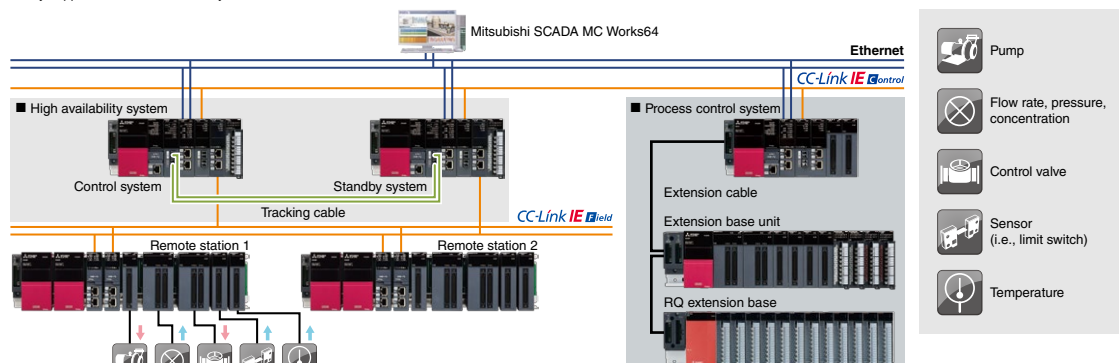



For further details, please refer to "iQ Platform C Controller" catalog and "MELSEC iQ-R Series e-Factory Advanced Information Modules" Broadcast.
L(NA)08165E, R005ENG

C Controller ^{iQ} Platform

Open platform utilizing edge computing for optimizing productivity

iQ-R series Q series

C Controller

Robust and deterministic alternative to microcomputer/computer based systems

The MELSEC C Controller product range is capable of programming using C language and offers a realistic alternative to mainstream microcomputer/computer based systems. Being part of the MELSEC Series, the C Controller utilizes its robust industrial design and long product life cycle, offering an easy way to realize a cost-efficient solution together with supporting partner products, open source and custom-made applications. This lineup is further enhanced with the new MELSEC iQ-R Series multi-core Arm®-based C Controller.

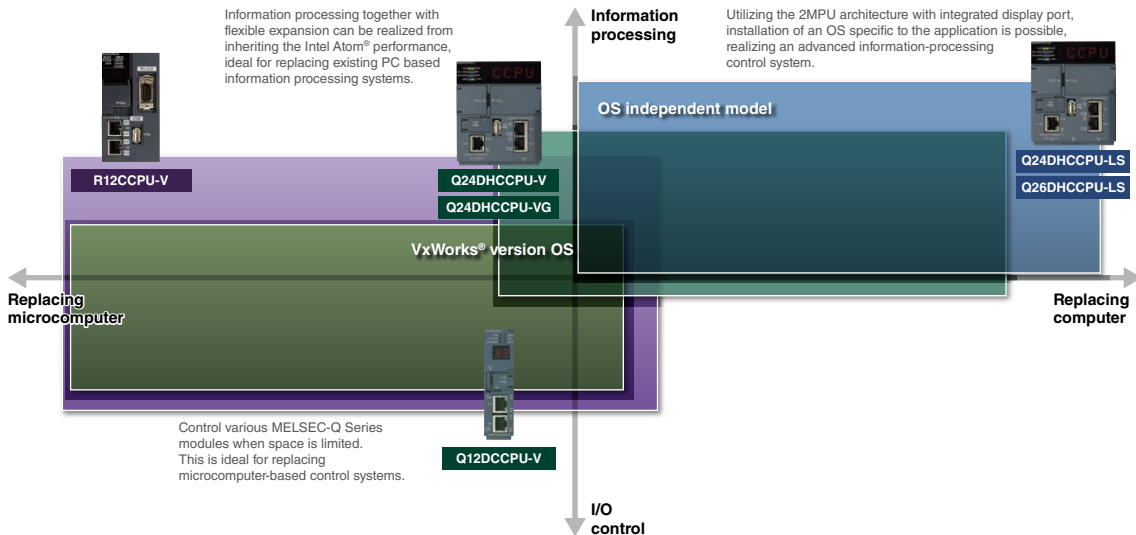

Easier to configure various control systems

Highly customizable solution enables the integration of partner products, open source applications, and OS-independent capabilities onto a generic open platform.

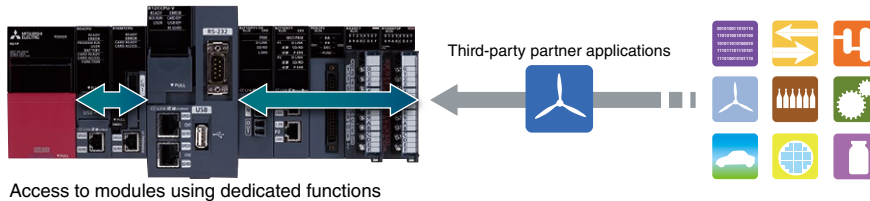

Reduce common overhead expenses realizing a cost effective solution

The C Controller platform is a solution that realizes computer-level functionality without the burden of high maintenance costs usually associated with computers. In addition, by being based on the MELSEC control system, the C Controller has a robust design that is ideal for industrial environments.

Common drawbacks associated with embedded and industrial computers	Merits of using MELSEC hardware
<ul style="list-style-type: none"> ● Discontinued production of boards & chips ● Specialized, costly driver development ● Short product life cycle ● Large physical space required ● Frequent maintenance required 	<ul style="list-style-type: none"> ● Highly reliable, long-term stable supply ● Utilization of C language programs ● Significantly reduced maintenance costs ● Reduced equipment size ● Total solution provided by a large number of I/Os and seamless network access
<p>Old Platform (Microcomputer/computer)</p> <ul style="list-style-type: none"> ● Disrupted product supply due to discontinued production ● Escalating management and maintenance costs 	<p>New Platform (MELSEC-Q/ MELSEC iQ-R)</p> <ul style="list-style-type: none"> ● Stable product supply ● Lower maintenance and management costs allows resources to be focused on development



For further details, please refer to "Mitsubishi iQ-R Series" and "Mitsubishi iQ-F Series" catalogs.

L (NA)03100ENG, L (NA)03062

SERVO SYSTEM CONTROLLER **iQ** Platform

Total system performance leads to maximum performance

- iQ-R series**
- Q series**
- L series**
- iQ-F series**

Servo System Controller

Lineup capable of responding to versatile sizes and applications

A full lineup of servo system controllers from Simple Motion modules to Motion CPUs supports all types of system configurations. Simple Motion modules are ideal for simple positioning control, and Motion CPUs are capable of controlling high-speed, multi-axis systems.

Simple motion module

- MELSEC iQ-R Series
- MELSEC-Q Series
- MELSEC-L Series
- MELSEC iQ-F Series

- Simple positioning is executed simply by setting sequence programs
- Advanced synchronous control and cam control are available
- Safety system can be configured using the Functional Safety Unit.

Motion CPU

- MELSEC iQ-R Series
- MELSEC-Q Series

- Increases productivity by supporting the iQ Platform
- Advanced synchronous control and cam control are available
- Safety system can be configured using the Functional Safety Unit.

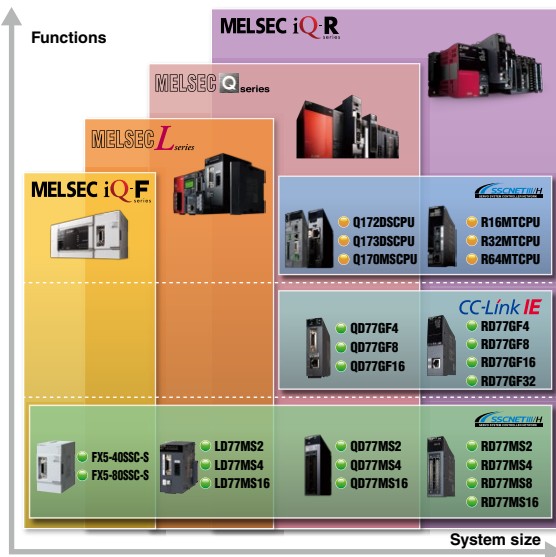

Extensive motion control

Positioning, speed-torque (press-fit) and advanced synchronous control among other forms of motion control for various equipment, including X-Y table, packaging and press-fitting machines. Ideal features designed to provide optimal solutions for machines and applications.

Control

Versatile motion control support different machine operations.

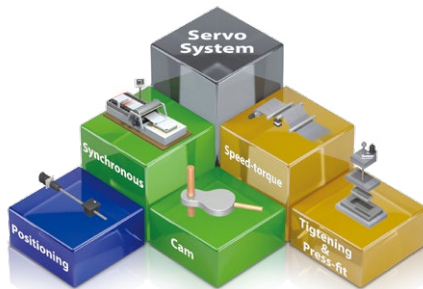

Functions

Select the functions best suited to match equipment requirements from an extensive list of options.

Cam auto-generation	Mark detection function	Optional data monitor	Absolute position system
Unlimited length feed	Target position change function	Safety observation function	M-code output
Digital oscilloscope function	Master-slave operation	Vision system	

Servo Amplifiers

High-accuracy positioning and smooth constant-speed operation can be achieved with a combination of the MELSEC iQ-R series servo system controllers and MELSERVO-J4 series servo amplifiers.

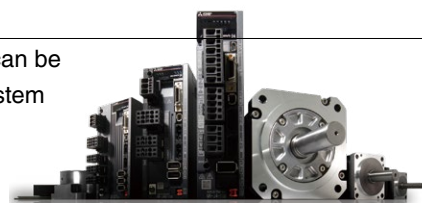



For further details, please refer to "MITSUBISHI ELECTRIC INDUSTRIAL ROBOT FR Series" catalog.
L(NA)-09091ENG

ROBOT CONTROLLER **iQ** Platform

Opening up multiple communication options through integration to the iQ Platform

iQ-R series

Robot Controller

Leveraging the integration of robots into manufacturing lines

By integrating the use of MELFA robots into the iQ Platform, it's possible to leverage communication with the automation controller, motion control and HMI. Utilizing the multi-CPU capabilities and integrated network/engineering environment, optimizing productivity can be achieved regardless of how complex or demanding the application.

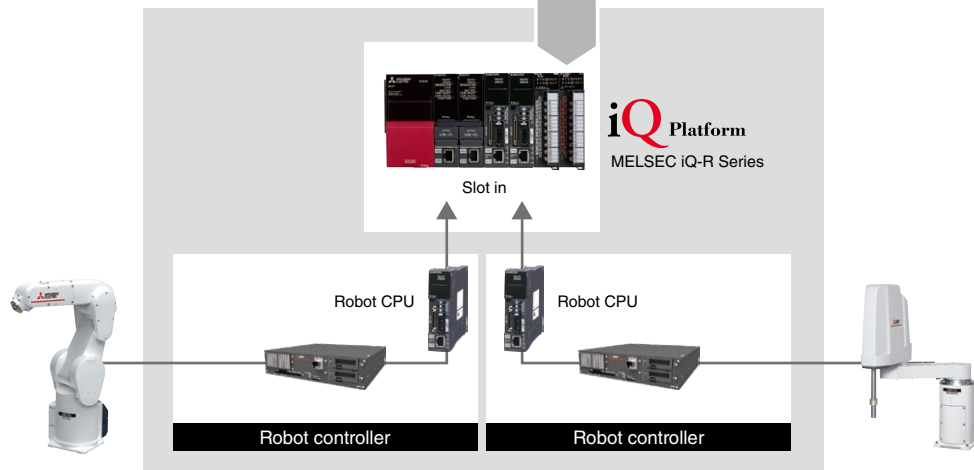
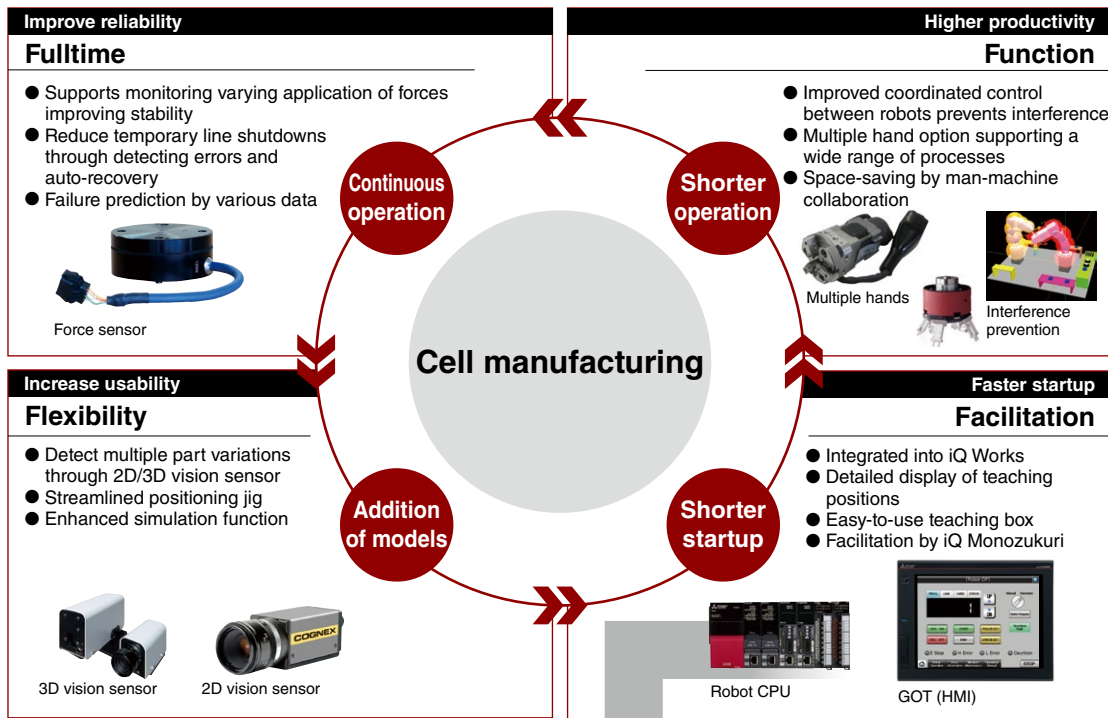



For further details, please refer to "MITSUBISHI CNC C80 Series" catalog.
K-KL2-6-C0226

CNC CPU iQ Platform

Providing maximum reduction in TCO

iQ-R series

CNC CPU

Integrating high-performance CNCs and high-speed programmable controllers

Integrate high-performance CNCs with the iQ Platform and experience substantially enhanced overall control system operation time, improving performance and enhancing productivity. Using standard modules contributes to reducing maintenance costs even further as replacements are generally available.

iQ Platform makes it possible to optimize controller use for various lines.

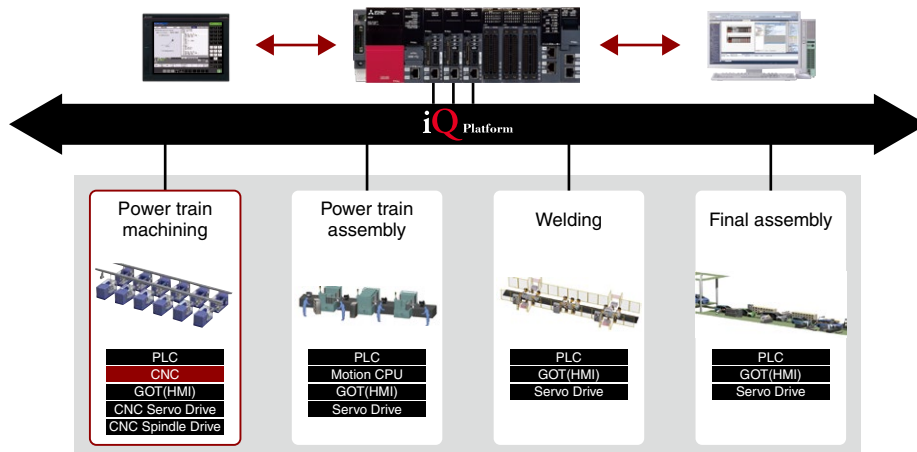

High-speed communication between CNCs and programmable controllers

High-speed CPU processing supported by fast communication bus speeds enable high-speed communication between controllers.

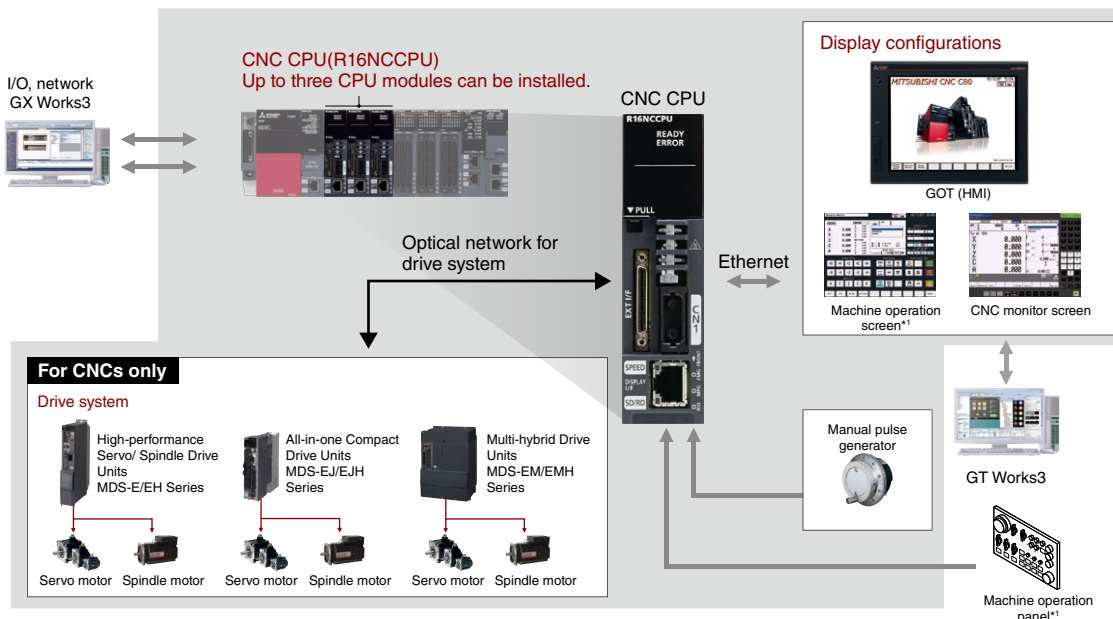

*1: Made by the machine tool builder

Engineering Software
MELSOFT iQ Works

Programmable controller engineering software **MELSOFT iQ Works**

MELSOFT iQ Works is an integrated software suite consisting of GX Works3, MT Works2, GT Works3, RT ToolBox3 and FR Configurator2, which are programming software for each respective product. Integration is further enhanced with MELSOFT Navigator as the central system configuration incorporating an easy-to-use, graphical user interface with additional project-sharing features such as system labels and parameters. The advantages of this powerful integrated software suite are that system design is made much easier with a substantial reduction in repetitious tasks, cutting down on errors while helping to reduce the overall TCO.

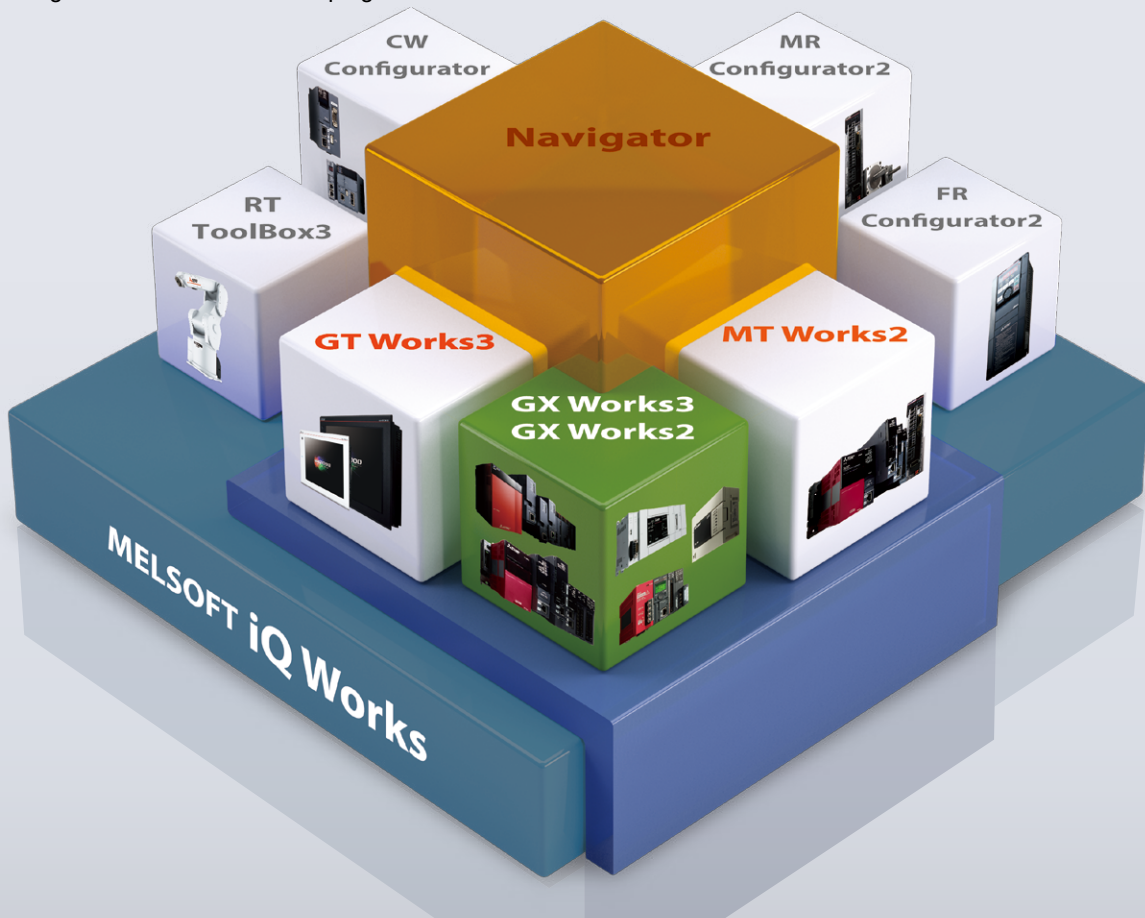

Programmable controller engineering software

MELSOFT GX Works3

Latest generation of software available for the MELSEC iQ-R and iQ-F Series control systems. Includes a graphic-based system configuration, integrated motion control setup, multiple language support, in addition to extensive diagnosis and troubleshooting functions.

MELSOFT GX Works2

Incorporating backward compatibility of programs created with GX Developer, GX Works2 further improves its functionality resulting in reduced engineering costs.

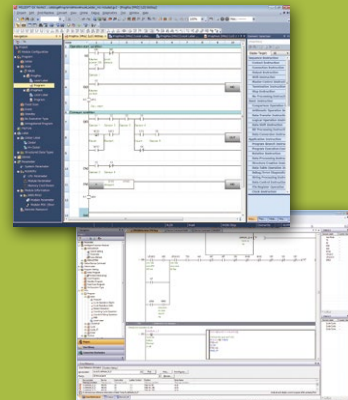



For further details, please refer to "MELSOFT IQ Works" catalog.
L(NA)08232ENG

System management software

MELSOFT Navigator

System level graphic-based configuration tool that simplifies the system design by providing a visual representation of the system. System management features such as system-wide parameterization, labels and block reading of project data are also included.

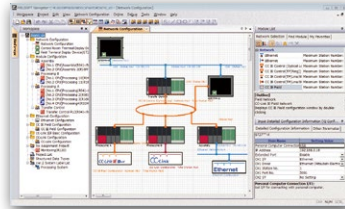

HMI/GOT screen design software

MELSOFT GT Works3

The GOT (Graphic Operation Terminal) screen creation software is designed with three main features; Simplicity, Graphics Design, and Easy-Usability, further helping to create graphic screens in fewer steps.



Motion controller engineering software

MELSOFT MT Works2

The motion control design and maintenance software includes intuitive graphic based programming together with a digital oscilloscope simulator.



Robot engineering software

MELSOFT RT ToolBox3*1

Supports various steps from programming, to commissioning, evaluation, and maintenance. In addition, improved preventative maintenance is realized through the use of an integrated 3D robot simulator.

*1: RT ToolBox3 mini (simplified version) will be installed if IQ Works product ID is used.
When RT ToolBox3 (with simulation function) is required, please purchase RT ToolBox3 product ID.

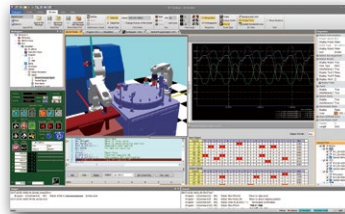

Inverter setup software

MELSOFT FR Configurator2

Simplifies the setup and maintenance of AC inverters. Parameters can be registered easily and distributed to multiple inverters when replacing, and activation of the PLC function all from one setup screen.

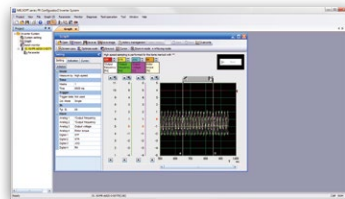

C Controller setting and monitoring tool

MELSOFT CW Configurator

This C Controller parameter setting and monitoring software simplifies parameter setting, diagnostics, monitoring and testing. Using CW Configurator is as easy as using the MELSEC IQ-R engineering software GX Works3, which shares similar interfaces.

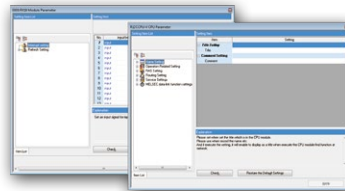

Servo setup software

MELSOFT MR Configurator2

Servo setup software used for easy monitoring, diagnosis, registering parameters, and testing of the servo amplifier.

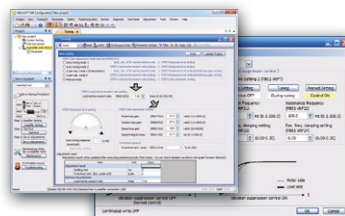

Programmable controller engineering software

GX Works3

Reducing development costs through intuitive engineering

The engineering software is sometimes considered a fundamental part of the control system in addition to the hardware components. The core of the system, it includes various steps of the product life cycle, from the design stage all the way to commissioning and maintenance of the control system. Today, intuitive, easy-to-use software suites are expected as a standard for modern manufacturing needs. GX Works3 is the latest generation of programming and maintenance software offered by Mitsubishi Electric specifically designed for the MELSEC iQ-R and MELSEC iQ-F Series control system. It includes many new features and technologies to ensure a trouble-free engineering environment solution.

Intuitive engineering software covering the product development cycle

Graphic-based configuration realizing easier programming

Various intuitive features such as graphic-based system configuration and an extensive module library (module label/FB) provided as standard.

Integrated motion-control system configuration

From setting simple motion module parameters and positioning data setup to servo amplifier configuration, everything is packaged into an easy-to-use engineering environment.

Complies with IEC 61131-3

GX Works3 realizes structured programming such as ladder and ST, making project standardization across multiple users even easier.

Simple point and click programming architecture

System design Programming Debug/maintenance

Straightforward graphic based system configuration design

- Simply drag and drop from the module list to easily create system configuration
- Directly setup parameters for each module
- Automatically reflect changes in the layout to the module parameters

System design Programming Debug/maintenance

MELSOFT library enables efficient programming through "Module Label/FB"

- Assign convenient label names to internal devices, rather than manually entering a device name every time
- Simply drag & drop module FBs from the MELSOFT Library directly into the ladder program, making programming even easier

System design Programming Debug/maintenance

Extensive version control features

- Flexibly register program change (historical) save points
- Easily visualize and confirm program changes

Global realization by multi-language support

To adhere to today's global production needs, GX Works3 supports multi-language features at various levels, from the multiple language software menu to the device comment language switching feature.

Navigation window

Easily access project components
Organize program file list.

Module configuration

Easily parameterize each module directly from the configuration editor.

Module list

Simply drag & drop modules directly into the module configuration.

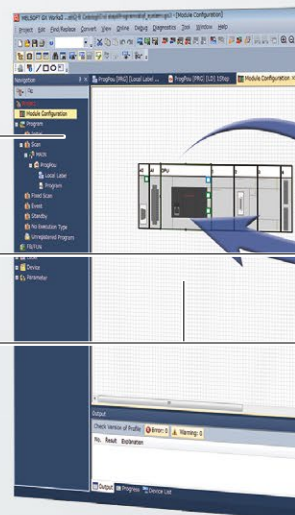



For further details, please refer to "Programmable controller engineering software MELSOFT GX Works3".

L(NA)08334ENG

GX Works3

One Software, Many Possibilities

Reduce engineering time by 60%*2

Tab view multiple editors

Conveniently work on multiple editors without having to switch software screens.

Module label/FB

Automatically generate module function blocks simply by selecting one and placing it directly into the ladder editor.

Simple motion setting tool

Easily configure the simple motion module with this convenient integrated tool.

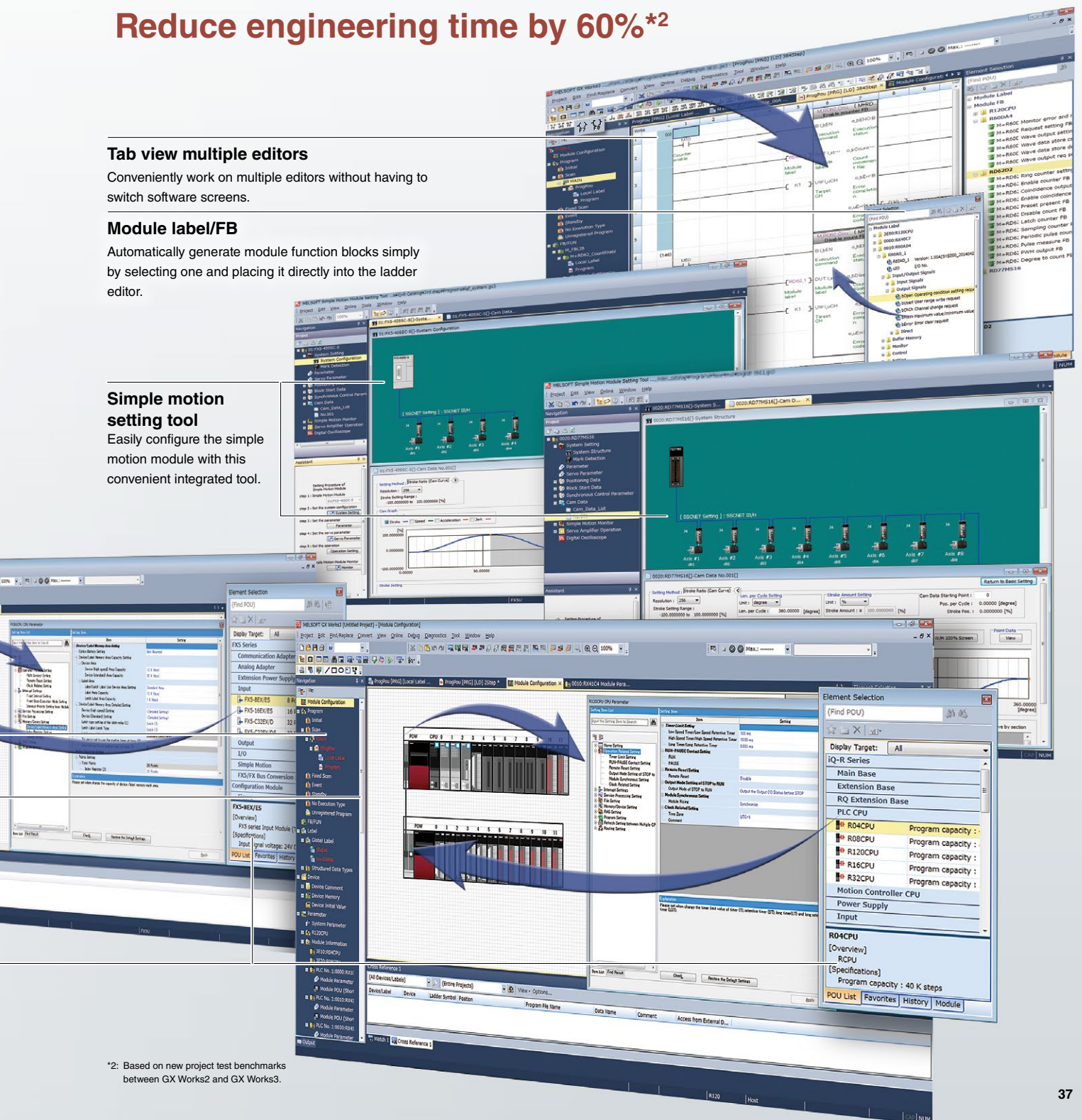

*2: Based on new project test benchmarks between GX Works2 and GX Works3.

Programmable controller engineering software

GX Works2

Easily setup intelligent function modules

Title display enables program contents to be checked at a glance

Project tree view showing the engineering process

Easily switch connection targets within the same window

Sample comments are available to quickly input comments

A comment for a word device can be set at bit level, differentiating similar devices

In-line ST for directly inserting operation instructions into the ladder

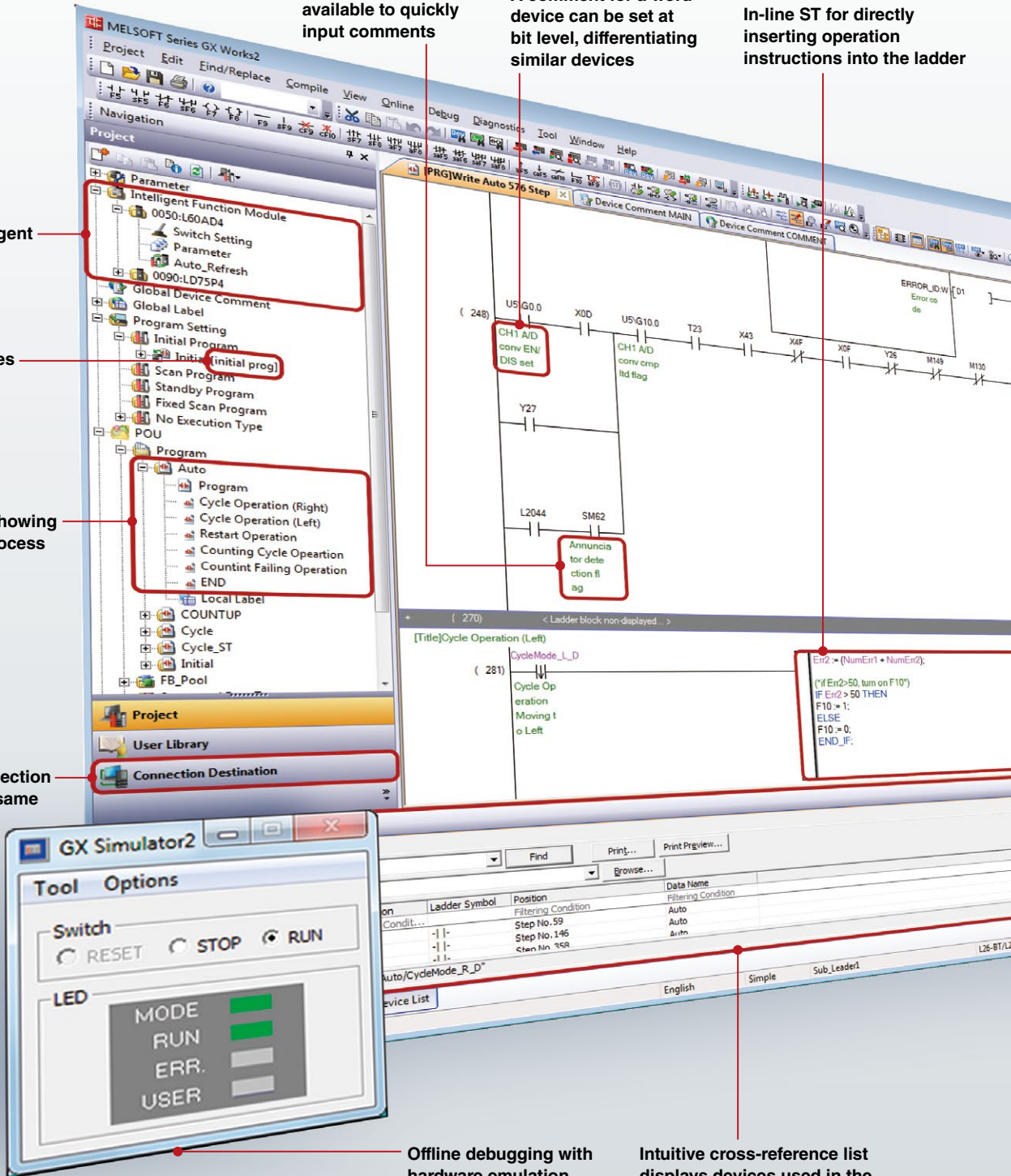

Offline debugging with hardware emulation

Intuitive cross-reference list displays devices used in the program



For further details, please refer to "iQ Platform Compatible Programmable Controller Engineering Software MELSOFT GX Works2" catalog.

L(NA)08122E

Engineering software designed for easy usability

GX Works2 has been designed to realize intuitive programming, maintenance, and debugging through various integrated features. The software supports IEC 61131-3 programming amongst the compatible programming languages, making it easy to use across multiple applications. It has an extensive maintenance features set, allowing easy setup of the control system, connected networks, and various intelligent I/O. GX Works2 is designed with customers in mind including consolidated "all-in-one" packaged programming that integrates programming, configuration and simulation tools.

Watch window for quick device/label monitoring

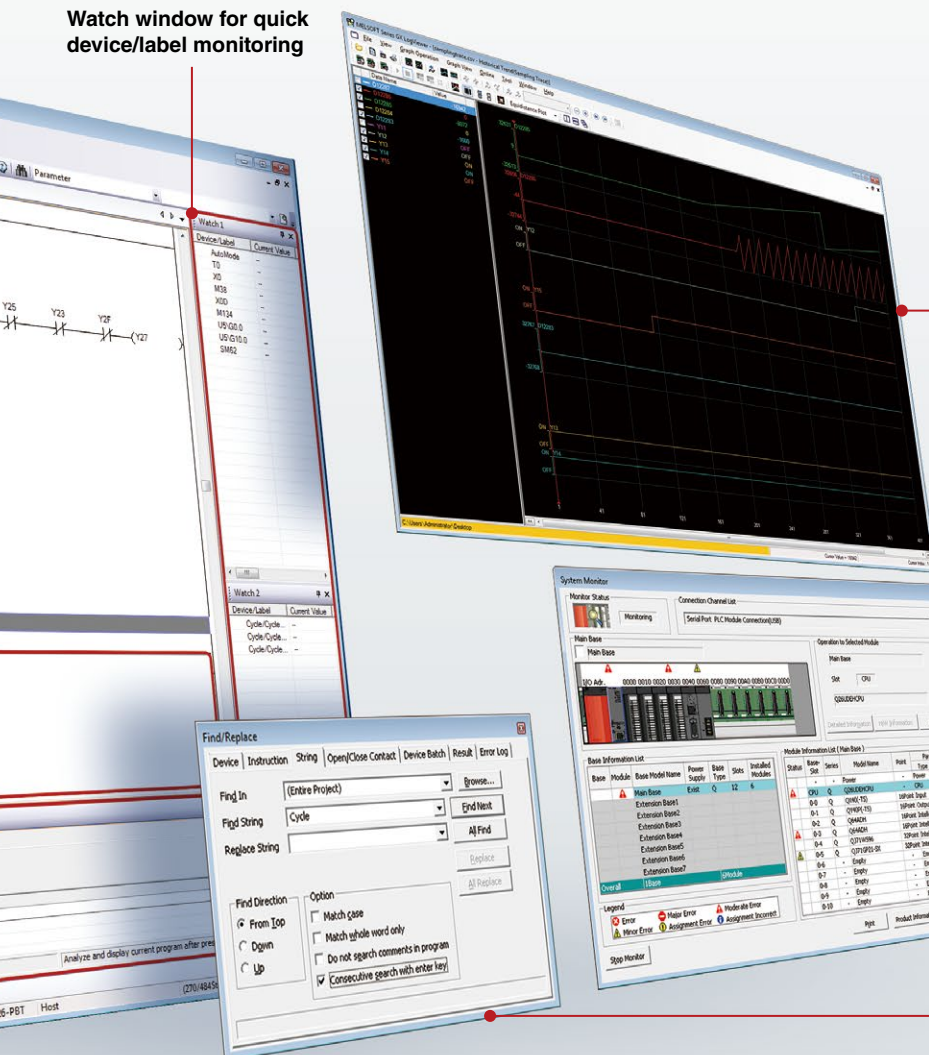

Sampling trace enables reduced setup and maintenance

System monitoring provides easier maintenance

Further simplify debugging with device search functionality

Intuitive project management

The project tree view, which is situated to the left of the docking window, enables easy understanding and management of the entire project. Various features such as viewing titles and handling multiple projects enable a very efficient and cost-effective way to manage projects, substantially reducing the overall engineering time. Project restoration is also easy using the back-up and restore feature.

Extensive program standardization

Program standardization is simplified using function blocks (FBs) within the program. The FBs make it easy to duplicate programming code that can be used multiple times in the project, or for other projects. This reduces programming time and realizes more efficient programming. A function library is also available, enabling standard FBs to be imported into projects, which saves on initial creation time.

Easy maintenance and debugging

Dedicated system monitoring and PLC diagnostics simplify control system maintenance and make error monitoring easy. Various security features are incorporated to protect intellectual property, such as controlling access to projects involving multi-person development teams using hierarchical-dependent access. Debugging using comments and project simulation is fairly easy, requiring no hardware.

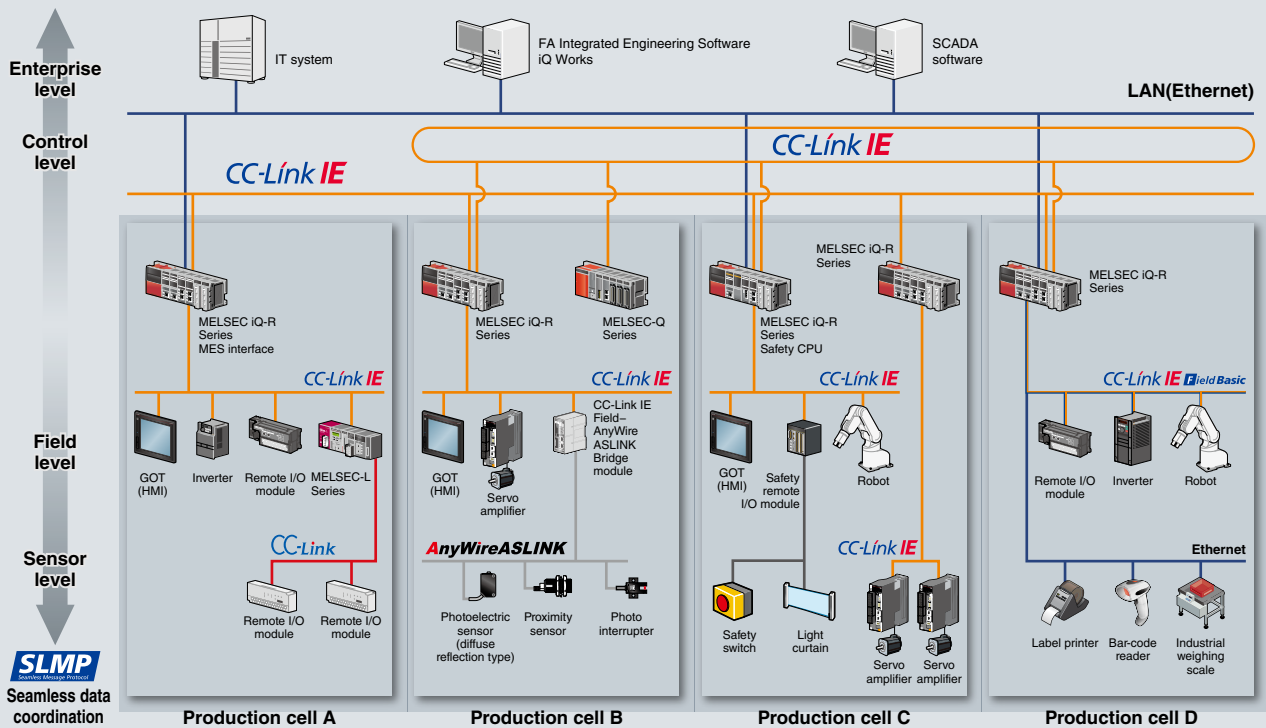

Extensive visualization with advanced data connectivity

Big Data analytics requires deterministic data collection, which can be realized by incorporating two key features: SLMP*1 that enables seamless connectivity between devices in the IT layer and on the shop floor; and a high-speed, large-capacity 1 Gbps communications network that enables the handling of large-data, such as production, quality and control data between different production processes.

General, motion and safety control integrated into one network

CC-Link IE incorporates generic distributed control, synchronous motion control, and safety control enabling safety communications across multiple safety devices, all on the same network. The topology is quite versatile, based on twisted-pair cables, which enables flexibility in system configuration while helping to keep installation cost low.

Comprehensive diagnosis realizing higher reliability

Disruptions to the control system are kept to a minimum via comprehensive diagnostics functions, high communications integrity owing to the noise-resistant characteristics of the optical cable, and communication re-routing capabilities made possible as the result of using a ring topology. Also, network errors can be rectified quickly by visualizing the network system image using the engineering software*2, and remotely from a GOT (HMI) directly on the machine or production line.

*1: Seamless Message Protocol

*2: MELSEC IQ-R Series is supported by GX Works3.

MELSEC-Q Series and MELSEC-L Series are supported by GX Works2.



For further details, please refer to "Ethernet-based Open Network CC-Link IE Product" and "Open Field Network CC-Link Compatible Product" catalogs.

L(NA)08111E, L(NA)08038E

Seamless connectivity within all levels of automation

The backbone of e-F@ctory, leveraging connectivity between the shop floor and IT



CC-Link IE Field network remote module

Input modules

DC input	AC input	Synchronized communication
Positive common Input 32, 16 points	Negative common 24 V DC	Positive/Negative common 100...120 V AC
Screw type	Sensor connector (e-CON)	MIL connector
Spring clamp terminal block	40-pin connector	

Output modules

Transistor output	Contact output	Triac output	Synchronized communication
Sink type Output 32, 16 points	Source type 12/24 V DC (0.5A)	12/24 V DC (0.1A)	
24 V DC (2A)	240 V AC (2A)	100...240 V AC (0.6A)	
Screw type	Sensor connector (e-CON)	MIL connector	
Spring clamp terminal block	40-pin connector		

I/O combined modules

DC input	Transistor output	Synchronized communication
Positive common Input 16 points	Negative common 24 V DC	Positive/Negative common
Sink type Output 16 points	Source type 12/24 V DC (0.5A)	12/24 V DC (0.1A)
24 V DC (0.5A)		
Screw type	Sensor connector (e-CON)	40-pin connector

Multiple input module

Analog voltage/current/temperature input	4 ch
Spring clamp terminal block	

Analog input modules

Synchronized communication		
Voltage/current input 4 ch	Voltage input 8 ch	Current input
Screw type	Sensor connector (e-CON)	

Analog output modules

Synchronized communication		
Voltage/current output Output 4 ch	Voltage output Output 8 ch	Current output
Screw type	Sensor connector (e-CON)	

Temperature control modules

Isolation between input channels	Transistor output
Thermocouple input 4 ch	RTD input
Screw type	Sink type

High-speed counter module

DC input	Differential input	Transistor output	Synchronized communication
200 kpps (DC input)	8 Mpps (Differential input)		
Coincidence output 2 ch	Sink type		
40-pin connector			

Extension modules

Input modules	DC input	Output modules	Transistor output
Positive/Negative common Input 16 points		Source type 24 V DC	
Sink type Output 16 points		Screw type	
Spring clamp terminal block			

Extension modules

Analog input module, Analog output module

Voltage/current input	4 ch
Voltage/current output	4 ch
Screw type	

Waterproof/dustproof type (IP67) input modules

DC input	
Positive common Input 16 points	Negative common 24 V DC
Waterproof connector	

Waterproof/dustproof type (IP67) output modules

Transistor output	
Sink type Output 16 points	Source type 12/24 V DC (2A)
Waterproof connector	

Waterproof/dustproof type (IP67) I/O combined modules

DC input	Transistor output
Positive common Input 8 points	Negative common 24 V DC
Sink type Output 8 points	Source type 12/24 V DC (2A)
Waterproof connector	

Main safety input module, Extension safety output module

Double wiring Input 16 points	24 V DC
Double wiring Output 4 points	24 V DC (0.5A)
Spring clamp terminal block	

MELSEC History

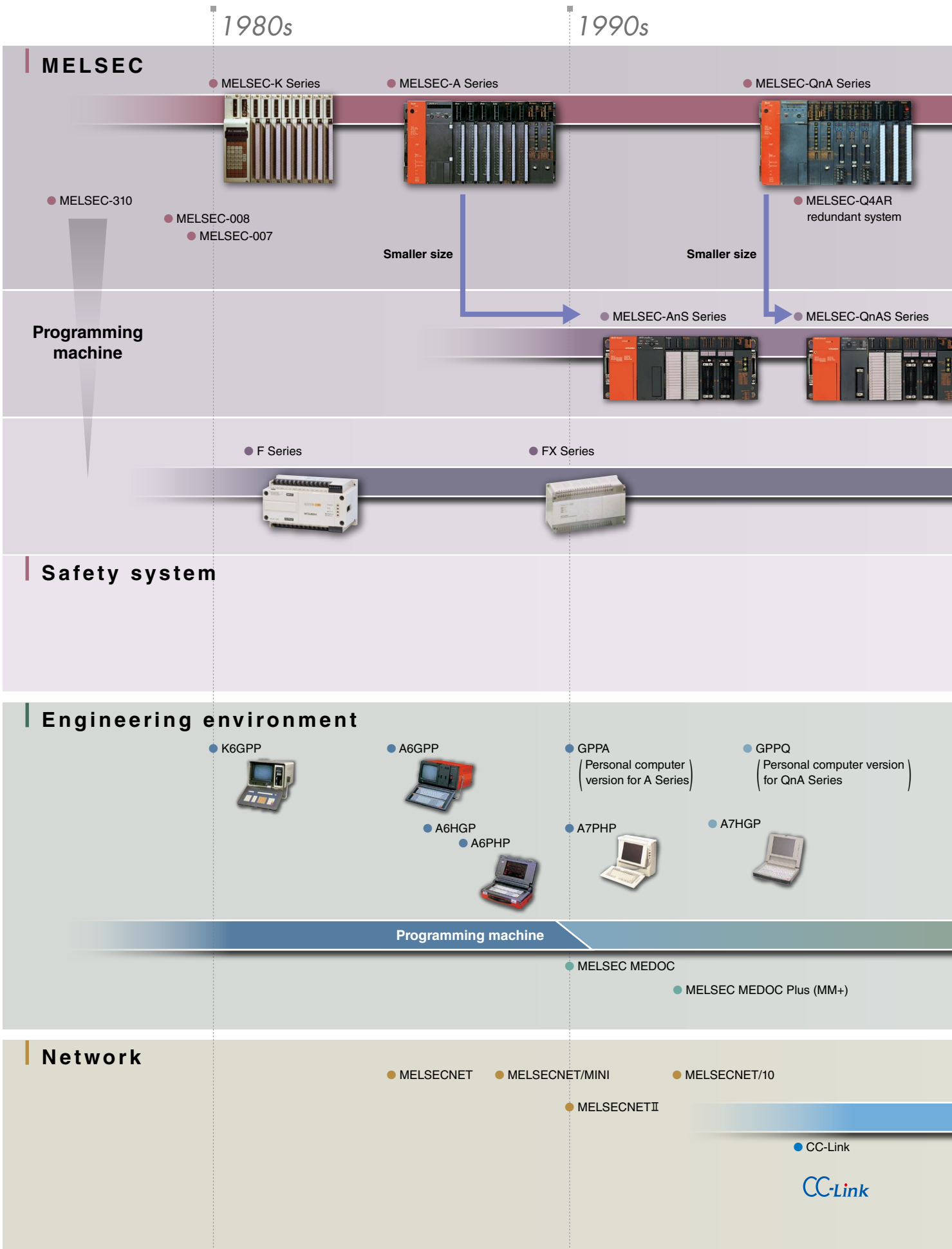

MELSEC with history and experience.
Satisfying new challenges while utilizing past expertise

2000s

2010s

● MELSEC-Q Series



- MELSEC-Q process CPU
- MELSEC-Q redundant system
- MELSEC-Q C Controller

Towards high functionality/performance

● MELSEC iQ-R Series



- MELSEC iQ-R C Controller
- MELSEC iQ-R Process CPU
 - MELSEC iQ-R SIL2 Process CPU
- MELSEC iQ-R CC-Link IE embedded CPU
- MELSEC iQ-R Safety CPU
 - MELSEC iQ-R redundant system
 - MELSEC iQ-R entry model CPU

Medium- to large-scale control

● MELSEC-L Series



Towards high functionality/performance

Small- to medium-scale control

● FX3 Series



Towards high functionality/performance

● MELSEC iQ-F Series



Small-scale and stand-alone

- MELSEC-QS Series Safety programmable controller
- MELSEC-WS Series safety controller



- MELSEC iQ-R Series Safety CPU



Safety control

● MELSOFT GX Developer (Windows® version GPP)

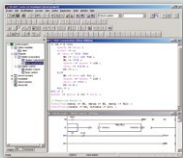

● MELSOFT iQ Works

● MELSOFT GX Works2

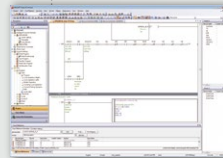

● MELSOFT GX Works3

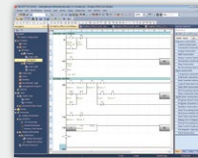

Personal computer software

- MELSOFT GX IEC Developer

● MELSECNET/H

- CC-Link/LT
- CC-Link Safety
- CC-Link IE Field
- CC-Link IE Control supporting twisted pair cable

- CC-Link IE Control
- CC-Link IE Field safety communication function
- CC-Link IE Field Basic

CC-Link IE

- CC-Link IE Field motion function

CC-Link IE Field Basic

Extensive global support coverage providing expert help whenever needed

■ Global FA centers

EMEA

Europe FA Center

MITSUBISHI ELECTRIC EUROPE B.V. Polish Branch
Tel: +48-12-347-65-81

Germany FA Center

MITSUBISHI ELECTRIC EUROPE B.V. German Branch
Tel: +49-2102-486-0 / Fax: +49-2102-486-1120

UK FA Center

MITSUBISHI ELECTRIC EUROPE B.V. UK Branch
Tel: +44-1707-27-8780 / Fax: +44-1707-27-8695

Czech Republic FA Center

MITSUBISHI ELECTRIC EUROPE B.V. Czech Branch
Tel: +420-255 719 200

Italy FA Center

MITSUBISHI ELECTRIC EUROPE B.V. Italian Branch
Tel: +39-039-60531 / Fax: +39-039-6053-312

Russia FA Center

MITSUBISHI ELECTRIC (RUSSIA) LLC ST.
Petersburg Branch
Tel: +7-812-633-3497 / Fax: +7-812-633-3499

Turkey FA Center

MITSUBISHI ELECTRIC TURKEY A.S. Umraniye Branch
Tel: +90-216-526-3990 / Fax: +90-216-526-3995

Asia-Pacific

China

Beijing FA Center

MITSUBISHI ELECTRIC AUTOMATION (CHINA) LTD.
Beijing FA Center
Tel: +86-10-6518-8830 / Fax: +86-10-6518-2938

Guangzhou FA Center

MITSUBISHI ELECTRIC AUTOMATION (CHINA) LTD.
Guangzhou FA Center
Tel: +86-20-8923-6730 / Fax: +86-20-8923-6715

Shanghai FA Center

MITSUBISHI ELECTRIC AUTOMATION (CHINA) LTD.
Shanghai FA Center
Tel: +86-21-2322-3030 / Fax: +86-21-2322-3000

Tianjin FA Center

MITSUBISHI ELECTRIC AUTOMATION (CHINA) LTD.
Tianjin FA Center
Tel: +86-22-2813-1015 / Fax: +86-22-2813-1017

Taiwan

Taipei FA Center

SETSUYO ENTERPRISE CO., LTD.
Tel: +886-2-2299-9917 / Fax: +886-2-2299-9963

Korea

Korea FA Center

MITSUBISHI ELECTRIC AUTOMATION KOREA CO., LTD.
Tel: +82-2-3660-9632 / Fax: +82-2-3664-0475

Thailand

Thailand FA Center

MITSUBISHI ELECTRIC FACTORY AUTOMATION
(THAILAND) CO., LTD.
Tel: +66-2682-6522-31 / Fax: +66-2682-6020

ASEAN

ASEAN FA Center

MITSUBISHI ELECTRIC ASIA PTE. LTD.
Tel: +65-6470-2480 / Fax: +65-6476-7439

Malaysia

Malaysia FA Center

Malaysia FA Center
Tel: +60-3-7626-5080 / Fax: +60-3-7658-3544

Indonesia

Indonesia FA Center

PT. MITSUBISHI ELECTRIC INDONESIA
Cikarang Office
Tel: +62-21-2961-7797 / Fax: +62-21-2961-7794

Vietnam

Hanoi FA Center

MITSUBISHI ELECTRIC VIETNAM COMPANY LIMITED
Hanoi Branch Office
Tel: +84-24-3937-8075 / Fax: +84-24-3937-8076

Ho Chi Minh FA Center

MITSUBISHI ELECTRIC VIETNAM COMPANY LIMITED
Tel: +84-28-3910-5945 / Fax: +84-28-3910-5947

Philippines

Philippines FA Center

MELCO Factory Automation Philippines Inc.
Tel: +63-(0)2-8256-8042

India

India Ahmedabad FA Center

MITSUBISHI ELECTRIC INDIA PVT. LTD.
Ahmedabad Branch
Tel: +91-7965120063

India Bangalore FA Center

MITSUBISHI ELECTRIC INDIA PVT. LTD.
Bangalore Branch
Tel: +91-80-4020-1600 / Fax: +91-80-4020-1699

India Chennai FA Center

MITSUBISHI ELECTRIC INDIA PVT. LTD.
Chennai Branch
Tel: +91-4445548772 / Fax: +91-4445548773

India Coimbatore FA Center

MITSUBISHI ELECTRIC INDIA PVT. LTD.
Coimbatore Branch
Tel: +91-422-438-5606

India Gurgaon FA Center

MITSUBISHI ELECTRIC INDIA PVT. LTD.
Gurgaon Head Office
Tel: +91-124-463-0300 / Fax: +91-124-463-0399

India Pune FA Center

MITSUBISHI ELECTRIC INDIA PVT. LTD.
Pune Branch
Tel: +91-20-2710-2000 / Fax: +91-20-2710-2100

Americas

USA

North America FA Center

MITSUBISHI ELECTRIC AUTOMATION, INC.
Tel: +1-847-478-2469 / Fax: +1-847-478-2253

Mexico

Mexico City FA Center

MITSUBISHI ELECTRIC AUTOMATION, INC.
Mexico Branch
Tel: +52-55-3067-7511

Mexico FA Center

MITSUBISHI ELECTRIC AUTOMATION, INC.
Queretaro Office
Tel: +52-442-153-6014

Mexico Monterrey FA Center

MITSUBISHI ELECTRIC AUTOMATION, INC.
Monterrey Office
Tel: +52-55-3067-7521

Brazil

Brazil FA Center

MITSUBISHI ELECTRIC DO BRASIL COMERCIO E
SERVICOS LTDA.
Tel: +55-11-4689-3000 / Fax: +55-11-4689-3016

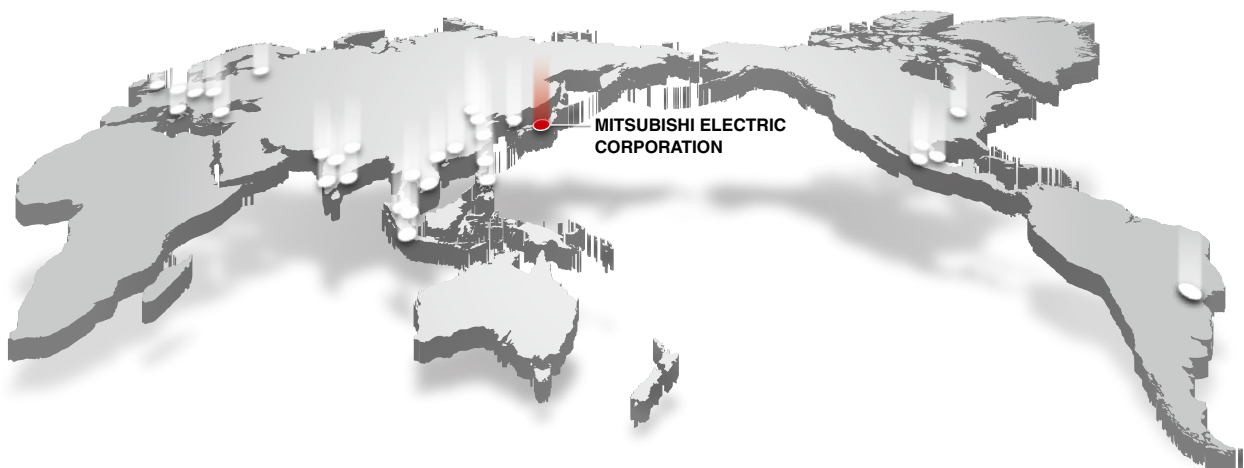

Factory Automation Global website

Mitsubishi Electric Factory Automation provides a mix of services to support its customers worldwide. A consolidated global website is the main portal, offering a selection of support tools and a window to its local Mitsubishi Electric sales and support network.

■ From here you can find:

- Overview of available factory automation products
- Library of downloadable literature
- Support tools such as online e-learning courses, terminology dictionary, etc.
- Global sales and service network portal
- Latest news related to Mitsubishi Electric factory automation



Mitsubishi Electric Factory Automation Global website:
www.MitsubishiElectric.com/fa

Mitsubishi Electric FA e-Learning

An extensive library of e-learning courses covering the factory automation product range. Courses from beginner to advanced levels of difficulty are available anytime anywhere.



- **Beginner level**
 Designed for newcomers to Mitsubishi Electric Factory Automation products gaining a background of the fundamentals and an overview of various products related to the course.
- **Basic to Advanced levels**
 Various different features are explained along with setup, programming, and network configuration.

Innovative next-generation e-Manual

A next-generation digital manual that consolidates factory automation products manuals into an easy-to-use package with various useful features.

- **e-Manual Viewer**
 Multiple manuals can be cross-searched at once. Multiple users can share the latest manuals and knowhow with document sharing function.



- **e-Manual Create**
 Software for converting word files and chm files to e-Manual documents. User's customized machine manuals can be converted to e-Manual documents, allowing consolidated management of user's maintenance information and Mitsubishi Electric product information.

Google Play is a trademark of Google LLC.
App Store is a service mark of Apple Inc.
Arm is a registered trademark of Arm Limited (or its subsidiaries) in the US and/or elsewhere.
BACnet is a registered trademark of the American Society of Heating, Refrigerating and Air-Conditioning Engineers, Inc.
CANopen is a registered trademark of CAN in Automation e.V.
Intel Atom is a trademark of Intel Corporation or its subsidiaries in the U.S. and/or other countries.
IOS is a registered trademark of Cisco in the U.S. and other countries and is used under license.
Microsoft, Windows, Access and Excel are registered trademarks of Microsoft Corporation in the United States and other countries.
MODBUS is a registered trademark of Schneider Electric USA, Inc.
OPC is a trademark of OPC Foundation.
QR Code is a trademark or a registered trademark of DENSO WAVE INCORPORATED in JAPAN, the United States and/or other countries.
SD/SDHC logo is a trademark of SD-3C, LLC.
Unicode is a registered trademark of Unicode, Inc. in the United States and other countries.
VxWorks is a registered trademark of Wind River Systems, Inc. in the United States and other countries.
All other company names and product names used in this document are trademarks or registered trademarks of their respective companies.

Precautions before use

This publication explains the typical features and functions of the products herein and does not provide restrictions or other information related to usage and module combinations. Before using the products, always read the product user manuals. Mitsubishi Electric will not be held liable for damage caused by factors found not to be the cause of Mitsubishi Electric; opportunity loss or lost profits caused by faults in Mitsubishi Electric products; damage, secondary damage, or accident compensation, whether foreseeable or not, caused by special factors; damage to products other than Mitsubishi Electric products; or any other duties.

For safe use

- To use the products given in this publication properly, always read the relevant manuals before beginning operation.
- The products have been manufactured as general-purpose parts for general industries, and are not designed or manufactured to be incorporated in a device or system used in purposes related to human life.
- Before using the products for special purposes such as nuclear power, electric power, aerospace, medicine or passenger-carrying vehicles, consult with Mitsubishi Electric.
- The products have been manufactured under strict quality control. However, when installing the products where major accidents or losses could occur if the products fail, install appropriate backup or fail-safe functions in the system.

YOUR SOLUTION PARTNER

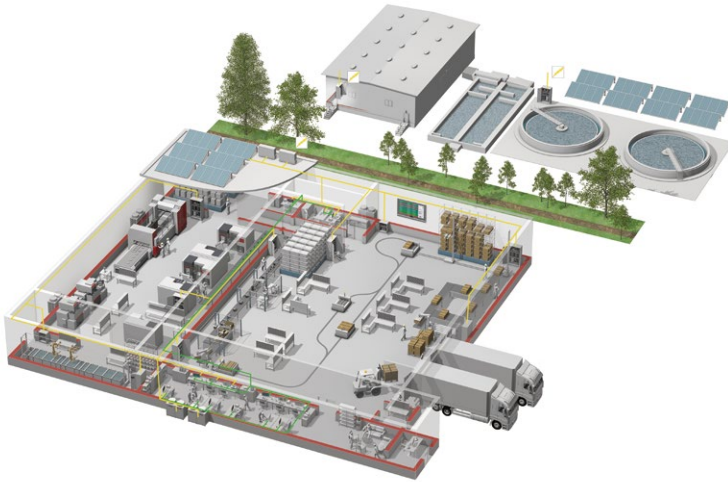

Mitsubishi Electric offers a wide range of automation equipment from PLCs and HMIs to CNC and EDM machines.

A NAME TO TRUST

Since its beginnings in 1870, some 45 companies use the Mitsubishi name, covering a spectrum of finance, commerce and industry.

The Mitsubishi brand name is recognized around the world as a symbol of premium quality.

Mitsubishi Electric Corporation, established in 1921, is active in space development, transportation, semi-conductors, energy systems, communications and information processing, audio visual equipment and home electronics, building and energy management and automation systems, and has 183 factories, laboratories and offices worldwide in over 140 countries.

This is why you can rely on Mitsubishi Electric automation solution - because we know first hand about the need for reliable, efficient, easy-to-use automation and control in our own factories.

As one of the world's leading companies with a global turnover of over 4 trillion Yen (over \$40 billion), employing over 146,000 people, Mitsubishi Electric has the resource and the commitment to deliver the ultimate in service and support as well as the best products.



Low-voltage Power Distribution Products



Transformers, Med-voltage Distribution Products



Power Monitoring and Energy Saving Products



Power (UPS) and Environmental Products



Compact and Modular Controllers



Servos, Motors and Inverters



Visualization: HMIs



Edge Computing Products



Numerical Control (NC)



Collaborative and Industrial Robots

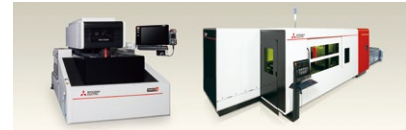

Processing machines: EDM, Lasers

* Not all products are available in all countries.

Country/Region	Sales office	Tel/Fax
USA	MITSUBISHI ELECTRIC AUTOMATION, INC. 500 Corporate Woods Parkway, Vernon Hills, IL 60061, U.S.A.	Tel : +1-847-478-2100 Fax : +1-847-478-2253
Mexico	MITSUBISHI ELECTRIC AUTOMATION, INC. Mexico Branch Boulevard Miguel de Cervantes Saavedra 301, Torre Norte Piso 5, Ampliacion Granada, Miguel Hidalgo, Ciudad de Mexico, Mexico, C.P.115200	Tel : +52-55-3067-7512
Brazil	MITSUBISHI ELECTRIC DO BRASIL COMERCIO E SERVICOS LTDA. Avenida Adelino Cardana, 293, 21 andar, Bethaville, Barueri SP, Brasil	Tel : +55-11-4689-3000 Fax : +55-11-4689-3016
Germany	MITSUBISHI ELECTRIC EUROPE B.V. German Branch Mitsubishi-Electric-Platz 1, 40882 Ratingen, Germany	Tel : +49-2102-486-0 Fax : +49-2102-486-7780
UK	MITSUBISHI ELECTRIC EUROPE B.V. UK Branch Travellers Lane, UK-Hatfield, Hertfordshire, AL10 8XB, U.K.	Tel : +44-1707-28-8780 Fax : +44-1707-27-8695
Ireland	MITSUBISHI ELECTRIC EUROPE B.V. Irish Branch Westgate Business Park, Ballymount, Dublin 24, Ireland	Tel : +353-1-4198800 Fax : +353-1-4198890
Italy	MITSUBISHI ELECTRIC EUROPE B.V. Italian Branch Centro Direzionale Colleoni - Palazzo Sirio, Viale Colleoni 7, 20864 Agrate Brianza (MB), Italy	Tel : +39-039-60531 Fax : +39-039-6053-312
Spain	MITSUBISHI ELECTRIC EUROPE, B.V. Spanish Branch Carretera de Rubi, 76-80-Apdo. 420, E-08190 Sant Cugat del Valles (Barcelona), Spain	Tel : +34-935-65-3131 Fax : +34-935-89-1579
France	MITSUBISHI ELECTRIC EUROPE B.V. French Branch 25, Boulevard des Bouvets, 92741 Nanterre Cedex, France	Tel : +33-1-55-68-55-68 Fax : +33-1-55-68-57-57
Czech Republic	MITSUBISHI ELECTRIC EUROPE B.V. Czech Branch, Prague Office Pekarska 621/7, 155 00 Praha 5, Czech Republic	Tel : +420-255-719-200
Poland	MITSUBISHI ELECTRIC EUROPE B.V. Polish Branch ul. Krakowska 48, 32-083 Balice, Poland	Tel : +48-12-347-65-00
Sweden	MITSUBISHI ELECTRIC EUROPE B.V. (Scandinavia) Hedvig Mollersgata 6, 223 55 Lund, Sweden	Tel : +46-8-625-10-00 Fax : +46-46-39-70-18
Russia	MITSUBISHI ELECTRIC (RUSSIA) LLC St. Petersburg Branch Piskarevsky pr. 2, bld 2, lit "Sch", BC "Benua", office 720; 195027 St. Petersburg, Russia	Tel : +7-812-633-3497 Fax : +7-812-633-3499
Turkey	MITSUBISHI ELECTRIC TURKEY A.S. Umraniye Branch Serifali Mah. Kale Sok. No:41 34775 Umraniye - Istanbul, Turkey	Tel : +90-216-969-2500 Fax : +90-216-661-4447
UAE	MITSUBISHI ELECTRIC EUROPE B.V. Dubai Branch Dubai Silicon Oasis, P.O.BOX 341241, Dubai, U.A.E.	Tel : +971-4-3724716 Fax : +971-4-3724721
South Africa	ADROIT TECHNOLOGIES 20 Waterford Office Park, 189 Witkoppen Road, Fourways, South Africa	Tel : +27-11-658-8100 Fax : +27-11-658-8101
China	MITSUBISHI ELECTRIC AUTOMATION (CHINA) LTD. Mitsubishi Electric Automation Center, No.1386 Hongqiao Road, Shanghai, China	Tel : +86-21-2322-3030 Fax : +86-21-2322-3000
Taiwan	SETSUYO ENTERPRISE CO., LTD. 6F, No.105, Wugong 3rd Road, Wugu District, New Taipei City 24889, Taiwan	Tel : +886-2-2299-2499 Fax : +886-2-2299-2509
Korea	MITSUBISHI ELECTRIC AUTOMATION KOREA CO., LTD. 7F to 9F, Gangseo Hangang Xi-tower A, 401, Yangcheon-ro, Gangseo-Gu, Seoul 07528, Korea	Tel : +82-2-3660-9569 Fax : +82-2-3664-8372
Singapore	MITSUBISHI ELECTRIC ASIA PTE. LTD. 307 Alexandra Road, Mitsubishi Electric Building, Singapore 159943	Tel : +65-6473-2308 Fax : +65-6476-7439
Thailand	MITSUBISHI ELECTRIC FACTORY AUTOMATION (THAILAND) CO., LTD. 12th Floor, SV.City Building, Office Tower 1, No. 896/19 and 20 Rama 3 Road, Kwaeng Bangpongpan, Khet Yannawa, Bangkok 10120, Thailand	Tel : +66-2682-6522-31 Fax : +66-2682-6020
Vietnam	MITSUBISHI ELECTRIC VIETNAM COMPANY LIMITED Unit 01-04, 10th Floor, Vincom Center, 72 Le Thanh Ton Street, District 1, Ho Chi Minh City, Vietnam	Tel : +84-28-3910-5945 Fax : +84-28-3910-5947
Indonesia	PT. MITSUBISHI ELECTRIC INDONESIA Gedung Jaya 8th Floor, JL. MH. Thamrin No.12, Jakarta Pusat 10340, Indonesia	Tel : +62-21-31926461 Fax : +62-21-31923942
India	MITSUBISHI ELECTRIC INDIA PVT. LTD. Pune Branch Emerald House, EL-3, J Block, M.I.D.C., Bhosari, Pune-411026, Maharashtra, India	Tel : +91-20-2710-2000 Fax : +91-20-2710-2100
Australia	MITSUBISHI ELECTRIC AUSTRALIA PTY. LTD. 348 Victoria Road, P.O. Box 11, Rydalmere, N.S.W 2116, Australia	Tel : +61-2-9684-7777 Fax : +61-2-9684-7245

MITSUBISHI ELECTRIC CORPORATION
HEAD OFFICE: TOKYO BLDG., 2-7-3, MARUNOUCHI, CHIYODA-KU, TOKYO 100-8310, JAPAN
www.MitsubishiElectric.com